

Code•Master™ LED Factory Sealed Luminaires

Explosionproof, Dust-Ignitionproof
Hazardous Locations.

NEC/CEC: Class I, Division 1 and 2, Groups B, C, D Ⓢ | Class I, Zone 1, Groups IIA, IIB, IIB + H₂ | Class II, Division 1, Group E, F, G | Class II, Division 2, Group F, G | Class III | Type 3R, 4X | IP66/67 | Simultaneous Exposure | Suitable for Use in Wet Locations | Marine Outside Type (Salt Water) ⌘ | Approved for use in Paint Spray Booths

Applications

- Explosionproof fixtures suitable for use in:
 - A wide range of hazardous areas where ignitable vapors, dust, moisture and corrosive elements are present.
 - Areas where access to relamp is difficult, reliability is essential, and environment is costly to maintain. Consistent light levels maintained regardless of cold temperatures.
 - Areas requiring frequent on-and-off of lights or power cycling- no warm up time required.
 - Type 4X, marine, wet locations and hose-down environments.
 - Areas with high energy costs - Code•Master LED consumes 50% or more less power than its HID equivalent.
- Typical applications include:
 - Chemical
 - Oil, Gas, and Petrochemical
 - Pulp and Paper
 - Foundries
 - Manufacturing
 - Waste and sewage treatment
 - Pharmaceutical
 - Mining
 - Power Generation
 - Paint Spray Booths
 - Hydrogen and Biofuels plants
 - LNG (Liquid Natural Gas) plants



- Universal, high efficiency, drivers cover voltage requirements for 120-277 Vac 50/60 Hz, 125-300 Vdc and 347-480 Vac, 50/60 Hz, Volts +/- 10%.
- 6 kV standard surge suppression for 347-480 Vac and 120-277 Vac input.
- Heavy duty, high temperature silicone gaskets.
- Reported L70 is > 76,000 hours.
- Photometric data and electronic drawings available upon request.
- Approved for use in paint spray booths.
- 5 year standard warranty.

Features

- Fixture operates safely in high ambient temperatures -40 °C up to +65 °C (-40 °F up to +149 °F).
- 60,000+ hours rated life eliminates the need for frequent relamping.
- Choice of color temperature (CCT): 5000K cool white, 4000K neutral white or 3000K warm white.
- Choice of optics for optimal light distribution in a variety of applications, NEMA Type V and Type V Wide.
- Arrangement of heat-producing components results in more efficient heat dissipation for cooler fixture operation.
- All threaded joints are flame-tight.
- Fixture housing and mounting hoods are copperfree cast aluminum with baked epoxy finish. All exposed hardware is stainless steel.
- Aluminum body utilizes the same Code•Master HID mounting hoods, and is an easy retrofit for existing Code•Master HID installations; can be pendant, ceiling, wall, or stanchion mounted.
- Acme double-lead threads speed installation and fixture removal from mounting hood – only half as many turns are required as for single-lead threads. The threads do not stick or gall, eliminating the troublesome problems often encountered with single lead threads during fixture unit removal.
- Safe, easy servicing without disconnecting any wiring. “Wireless” fixture unit easily threads off mounting hood for convenient servicing or for immediate replacement with a “stand-by” unit.
- Factory sealed. External seals not required.
- Globe and driver are all field replaceable.
- LED arrays generate light outputs from 3,700 to 19,000+ lumens (an equivalent of 100 W HID to 750 W HID lamps) providing exceptional efficacy.
- Choice of replaceable clear or diffused glass globe.

Standard Materials

- Mounting hoods and bodies: cast copperfree (4/10 of 1% max.) aluminum
- All hardware, catch assemblies and yoke bracket: stainless steel
- Gaskets: silicone
- Globe: explosionproof glass

Standard Finishes

- Mounting hoods, bodies, and guards: baked gray epoxy clad finish, electrostatically applied for complete uniform protection

Options

- Safety cable, add suffix **-C**.
- Lens guard, add suffix **-G**.
- Fusing, add suffix **-F** ⌘.

NEC/CEC Certifications and Compliances

- UL Standard: UL 50; UL 50E; UL 844; UL 1598; UL 1598A; UL 8750
- CSA Standard: CAN/CSA-C22.2 No. 94.1-07 (R2012); CAN/ CSA-C22.2 No. 94.2-07 (R2012); CAN/CSA-C22.2 No. 137- M1981 (R2009); CAN/ CSA-C22.2 No. 250.0-08 (R2013); CAN/ CSA-C22.2 No. 250.13; CAN/ CSA-C22.2 No. 60529-05 (R2010)
- ANSI Standard: ANSI/IEC 60529
- cCSAus Certified: 70030675

Design Lights™ Consortium

- Check DLC QPL for current list of products

Related Products

- Code•Master Jr. LED Factory Sealed Luminaires
- A-51 LED Factory Sealed Luminaires

Note: Complete Code•Master LED luminaire consists of fixture unit and a mounting hood.

⌘ Use of a fuse voids Marine Outside Type (Salt Water) rating.

Code•Master™ LED Factory Sealed Luminaires

Explosionproof, Dust-Ignitionproof
Hazardous Locations.

NEC/CEC: Class I, Division 1 and 2, Groups B, C, D Ⓢ | Class I, Zone 1, Groups IIA, IIB, IIB + H₂ | Class II, Division 1, Group E, F, G | Class II, Division 2, Group F, G | Class III | Type 3R, 4X | IP66/67 | Simultaneous Exposure | Suitable for Use in Wet Locations | Marine Outside Type (Salt Water) ⚡ | Approved for use in Paint Spray Booths

Illustrated Features



Mounting Hood Compatibility

Code•Master LED is compatible with existing Code•Master mounting hoods. For easy installation, install and wire the mounting hood and simply thread in fixture. Double lead Acme threads are provided for ease of installation.



Rugged and Durable Housing

Mounting hoods and bodies are copper free aluminum with baked epoxy-clad finish, electrostatically applied for complete uniform protection.

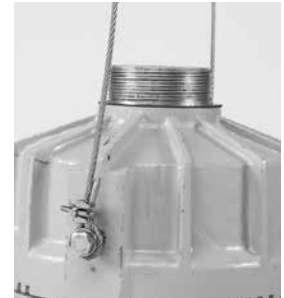

Optional Safety Cable

Provides secondary retention for lighting fixtures.



Driver Assembly

Driver can be easily accessed and replaced.



Optional Fusing ⚡

Fuse kit includes fuse, fuse holder and necessary hardware for field installation.



Optional Trunnion/Yoke Mount

Trunnion/yoke mount allows the fixture to be aimed in a desired position.



Replaceable Globe Assembly

The replaceable globe assembly is available with clear or diffuse glass.



Optional Wire Guard

Stainless steel wire guard can be used for additional protection.

Note: Complete Code•Master LED luminaire consists of fixture unit and a mounting hood.

⚡ Use of a fuse voids Marine Outside Type (Salt Water) rating.

Code•Master™ LED Factory Sealed Luminaires

Explosionproof, Dust-Ignitionproof
Hazardous Locations.

NEC/CEC: Class I, Division 1 and 2, Groups B, C, D ① | Class I, Zone 1, Groups IIA, IIB, IIB + H₂ | Class II, Division 1, Group E, F, G | Class II, Division 2, Group F, G | Class III | Type 3R, 4X | IP66/67 | Simultaneous Exposure | Suitable for Use in Wet Locations | Marine Outside Type (Salt Water) ⌘ | Approved for use in Paint Spray Booths

LED Luminaires | Area / Task | Hazardous Location — Explosionproof | NEC / CEC

Code•Master™ LED Factory Sealed Luminaires Family Tree

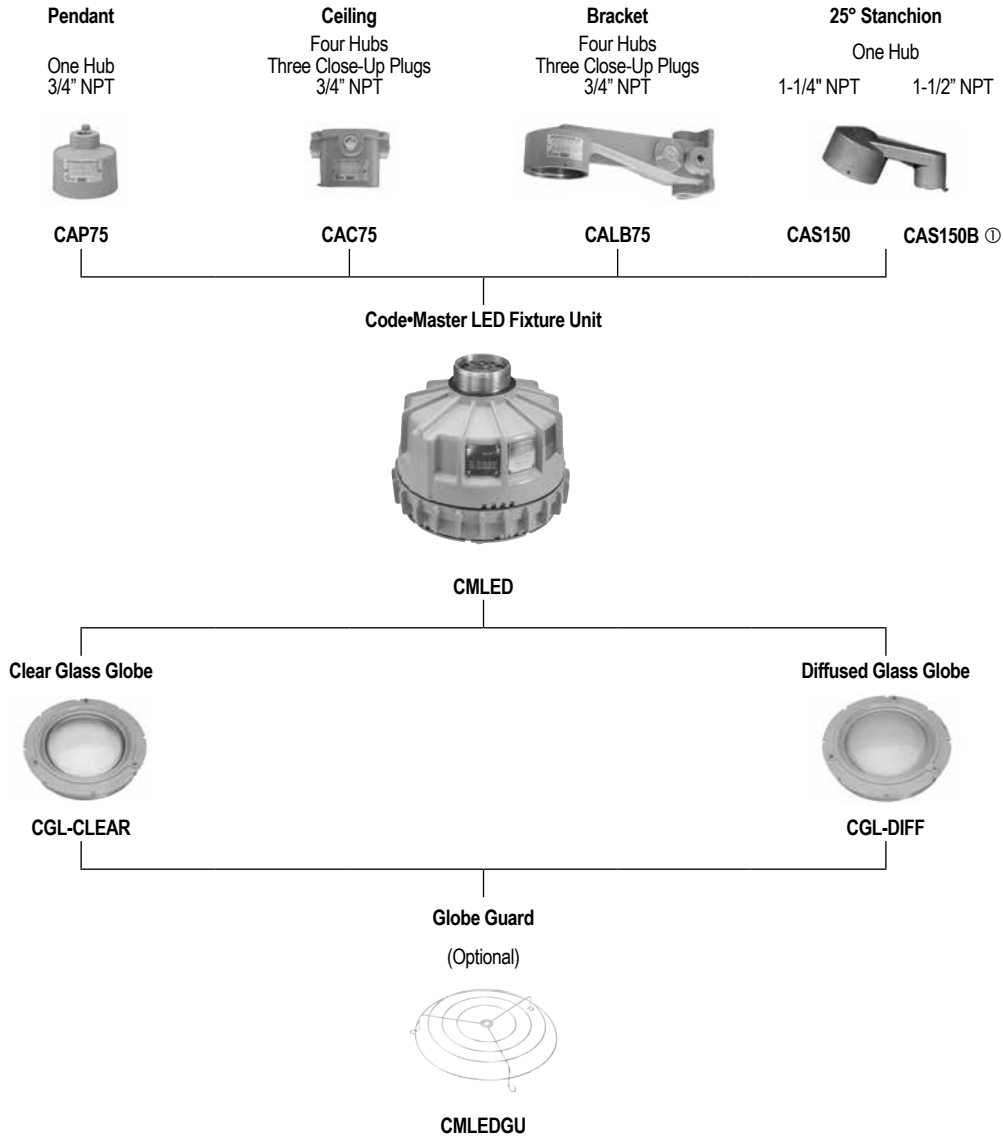

① When using the 25° Stanchion mounting hood in group B applications part number CAS-150B must be used.

Note: Complete Code•Master LED luminaire consists of fixture unit and a mounting hood.

⌘ Use of a fuse voids Marine Outside Type (Salt Water) rating.

Code•Master™ LED Factory Sealed Luminaires

Explosionproof, Dust-Ignitionproof
Hazardous Locations.

NEC/CEC: Class I, Division 1 and 2, Groups B, C, D ① | Class I, Zone 1, Groups IIA, IIB, IIB + H₂ | Class II, Division 1, Group E, F, G | Class II, Division 2, Group F, G | Class III | Type 3R, 4X | IP66/67 | Simultaneous Exposure | Suitable for Use in Wet Locations | Marine Outside Type (Salt Water) ⌘ | Approved for use in Paint Spray Booths

Order Using Catalog Numbering Guide — Code•Master™ LED Factory Sealed Luminaires

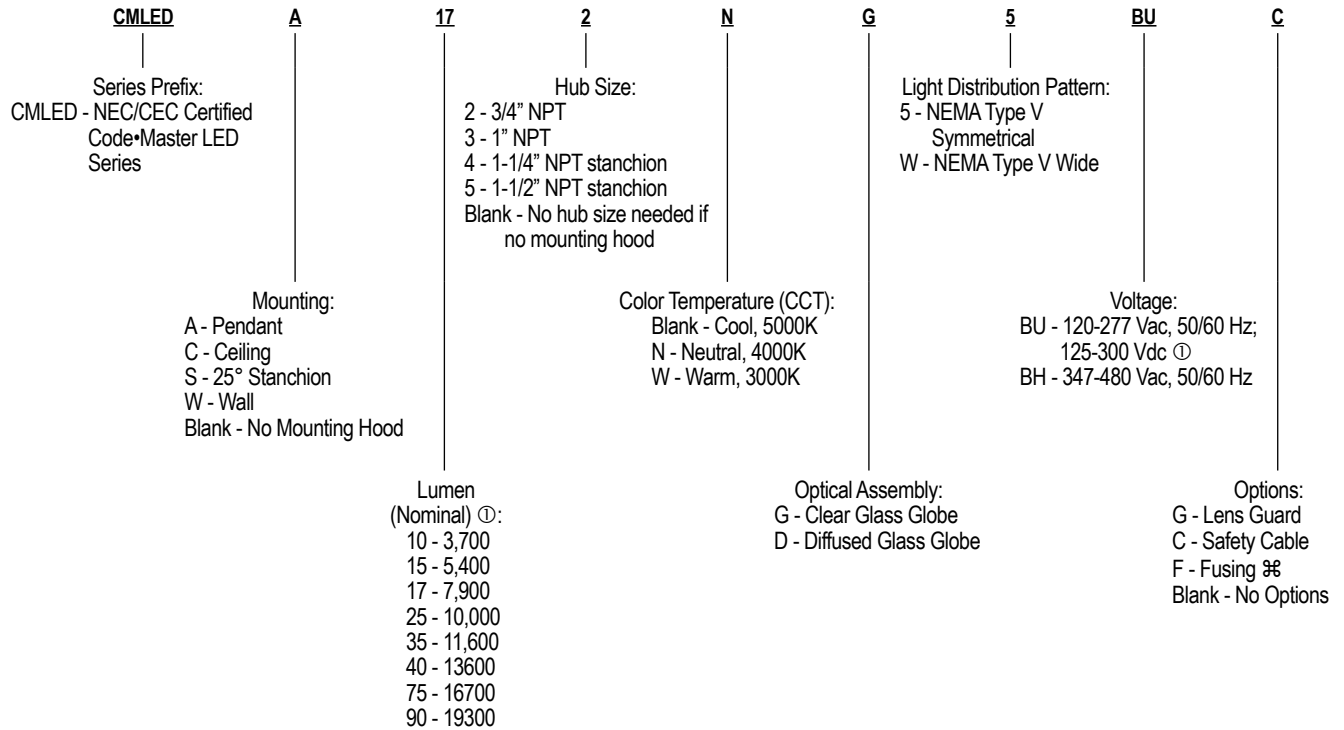

LED Luminaires | Area / Task | Hazardous Location — Explosionproof | NEC / CEC

Note: Complete Code•Master LED luminaire consists of fixture unit and a mounting hood.

① Nominal light value for 5000K clear glass globe.

⌘ Use of a fuse voids Marine Outside Type (Salt Water) rating.

Code•Master™ LED Factory Sealed Luminaires

Explosionproof, Dust-Ignitionproof
Hazardous Locations.

NEC/CEC: Class I, Division 1 and 2, Groups B, C, D Ⓢ | Class I, Zone 1, Groups IIA, IIB, IIB + H₂ | Class II, Division 1, Group E, F, G | Class II, Division 2, Group F, G | Class III | Type 3R, 4X | IP66/67 | Simultaneous Exposure | Suitable for Use in Wet Locations | Marine Outside Type (Salt Water) Ⓢ | Approved for use in Paint Spray Booths

LED Luminaires | Area / Task | Hazardous Location — Explosionproof | NEC / CEC

Lumen Output (Efficacy) ①

Model	HID Equivalency	Light Distribution Pattern	CCT (Correlated Color Temperature)	CRI (Color Rendering Index)	Lumen Output	Efficacy (lm/W)	CCT	CRI	Lumen Output	Efficacy (lm/W)	CCT	CRI	Lumen Output	Efficacy (lm/W)
Clear Glass Globe														
CMLED10	100W	Type V	3000K	80	3200	106	4000K	80	3600	117	5000K	70	3700	123
		Type V Wide	3000K	80	3000	97	4000K	80	3300	108	5000K	70	3300	108
CMLED15	150W	Type V	3000K	80	4600	104	4000K	80	5100	115	5000K	70	5400	120
		Type V Wide	3000K	80	4200	95	4000K	80	4700	105	5000K	70	5000	112
CMLED17	175W	Type V	3000K	80	7200	120	4000K	80	7900	131	5000K	70	7900	132
		Type V Wide	3000K	80	6500	108	4000K	80	7100	118	5000K	70	7200	120
CMLED25	250W	Type V	3000K	80	9100	119	4000K	80	9900	130	5000K	70	10000	130
		Type V Wide	3000K	80	8000	105	4000K	80	8800	115	5000K	70	8900	117
CMLED35	350W	Type V	3000K	80	10600	117	4000K	80	11600	128	5000K	70	11600	128
		Type V Wide	3000K	80	9400	103	4000K	80	10300	113	5000K	70	10400	115
CMLED40	400W	Type V	3000K	80	12000	117	4000K	80	13500	131	5000K	70	13600	131
		Type V Wide	3000K	80	10600	103	4000K	80	11600	112	5000K	70	11800	114
CMLED75	600W	Type V	3000K	80	14700	112	4000K	80	16600	127	5000K	70	16700	126
		Type V Wide	3000K	80	13000	99	4000K	80	14200	109	5000K	70	14500	110
CMLED90	750W	Type V	3000K	80	17100	109	4000K	80	19300	122	5000K	70	19300	123
		Type V Wide	3000K	80	15000	95	4000K	80	16400	105	5000K	70	16700	106
Diffused Glass Globe														
CMLED10	100W	Type V	3000K	80	2800	91	4000K	80	3100	100	5000K	70	3200	106
		Type V Wide	3000K	80	2300	76	4000K	80	2600	84	5000K	70	2600	84
CMLED15	150W	Type V	3000K	80	4000	89	4000K	80	4400	99	5000K	70	4600	104
		Type V Wide	3000K	80	3300	75	4000K	80	3700	83	5000K	70	3900	88
CMLED17	175W	Type V	3000K	80	5900	99	4000K	80	6500	109	5000K	70	6500	109
		Type V Wide	3000K	80	5200	86	4000K	80	5600	94	5000K	70	5700	95
CMLED25	250W	Type V	3000K	80	7500	98	4000K	80	8200	107	5000K	70	8300	108
		Type V Wide	3000K	80	6400	84	4000K	80	7000	91	5000K	70	7100	92
CMLED35	350W	Type V	3000K	80	8800	96	4000K	80	9600	106	5000K	70	9600	106
		Type V Wide	3000K	80	7500	82	4000K	80	8200	90	5000K	70	8300	91
CMLED40	400W	Type V	3000K	80	9900	96	4000K	80	11200	108	5000K	70	11200	109
		Type V Wide	3000K	80	8500	82	4000K	80	9200	90	5000K	70	9400	91
CMLED75	600W	Type V	3000K	80	12200	93	4000K	80	13700	104	5000K	70	13700	104
		Type V Wide	3000K	80	10400	79	4000K	80	11300	86	5000K	70	11500	88
CMLED90	750W	Type V	3000K	80	14100	90	4000K	80	15700	100	5000K	70	15800	101
		Type V Wide	3000K	80	12000	76	4000K	80	13100	83	5000K	70	13200	84

① All lumen values are typical (tolerance +/-10%).

Note: Complete Code•Master LED luminaire consists of fixture unit and a mounting hood.

Ⓢ Use of a fuse voids Marine Outside Type (Salt Water) rating.

Code•Master™ LED Factory Sealed Luminaires

Explosionproof, Dust-Ignitionproof
Hazardous Locations.

NEC/CEC: Class I, Division 1 and 2, Groups B, C, D Ⓢ | Class I, Zone 1, Groups IIA, IIB, IIB + H₂ | Class II, Division 1, Group E, F, G | Class II, Division 2, Group F, G | Class III | Type 3R, 4X | IP66/67 | Simultaneous Exposure | Suitable for Use in Wet Locations | Marine Outside Type (Salt Water) Ⓢ | Approved for use in Paint Spray Booths

Electrical Specifications ①					
Model	Voltage	Input Power (Watts)	Input Current (Amp)	Power Factor (PF)	Total Harmonic Distortion (THD)
CMLED10	120 Vac	30	0.26	>.95	<20%
	277 Vac	31	0.12	>.90	<20%
	125 Vdc	31	0.25	N/A	N/A
	300 Vdc	31	0.10	N/A	N/A
	347 Vac	32	0.09	>.95	<20%
	480 Vac	32	0.07	>.90	<20%
CMLED15	120 Vac	45	0.38	>.99	<20%
	277 Vac	44	0.17	>.95	<20%
	125 Vdc	45	0.36	N/A	<20%
	300 Vdc	45	0.15	N/A	<20%
	347 Vac	45	0.13	>.95	<20%
	480 Vac	45	0.10	>.95	<20%
CMLED17	120 Vac	60	0.50	>.99	<20%
	277 Vac	59	0.24	>.90	<20%
	125 Vdc	60	0.98	N/A	<20%
	300 Vdc	60	0.20	N/A	<20%
	347 Vac	60	0.18	>.95	<20%
	480 Vac	60	0.14	>.90	<20%
CMLED25	120 Vac	76	0.64	>.99	<20%
	277 Vac	75	0.29	>.90	<20%
	125 Vdc	77	0.62	N/A	<20%
	300 Vdc	76	0.25	N/A	<20%
	347 Vac	78	0.23	>.95	<20%
	480 Vac	78	0.17	>.90	<20%
CMLED35	120 Vac	91	0.76	>.99	<20%
	277 Vac	89	0.34	>.95	<20%
	125 Vdc	91	0.73	N/A	<20%
	300 Vdc	89	0.30	N/A	<20%
	347 Vac	91	0.27	>.99	<20%
	480 Vac	91	0.20	>.95	<20%
CMLED40	120 Vac	103	0.85	>.95	<20%
	277 Vac	98	0.39	>.90	<20%
	125 Vdc	101	0.81	N/A	N/A
	300 Vdc	98	0.33	N/A	N/A
	347 Vac	102	0.30	>.99	<20%
	480 Vac	102	0.22	>.95	<20%
CMLED75	120 Vac	132	1.10	>.99	<20%
	277 Vac	126	0.48	>.90	<20%
	125 Vdc	130	1.04	N/A	N/A
	300 Vdc	126	0.42	N/A	N/A
	347 Vac	130	0.38	>.99	<20%
	480 Vac	130	0.28	>.95	<20%
CMLED90	120 Vac	157	1.35	>.99	<20%
	277 Vac	155	0.58	>.90	<20%
	125 Vdc	161	1.29	N/A	N/A
	300 Vdc	156	0.52	N/A	N/A
	347 Vac	159	0.46	>.99	<20%
	480 Vac	158	0.33	>.95	<20%

① All values are typical (tolerance +/-10%).

Note: Complete Code•Master LED luminaire consists of fixture unit and a mounting hood.

Ⓢ Use of a fuse voids Marine Outside Type (Salt Water) rating.

LED Luminaires | Area / Task | Hazardous Location — Explosionproof | NEC / CEC

Code•Master™ LED Factory Sealed Luminaires

Explosionproof, Dust-Ignitionproof
Hazardous Locations.

NEC/CEC: Class I, Division 1 and 2, Groups B, C, D ① | Class I, Zone 1, Groups IIA, IIB, IIB + H₂ | Class II, Division 1, Group E, F, G | Class II, Division 2, Group F, G | Class III | Type 3R, 4X | IP66/67 | Simultaneous Exposure | Suitable for Use in Wet Locations | Marine Outside Type (Salt Water) ⌘ | Approved for use in Paint Spray Booths

LED Luminaires | Area / Task | Hazardous Location — Explosionproof | NEC / CEC

NEC/CEC Temperature Codes

Type ①	Ambient Temperature °C (°F)	Supply Wire Temperature °C (°F)	Class I, Division 1 (Gas)	Class I, Zone 1 (Gas)	Class II Division 1 (Dust) and Simultaneous Exposure
CMLED10	+40 (+104)	+90 (+104)	T6	T6	T6
	+55 (+131)	+90 (+104)	T6	T6	T6
	+65 (+140)	+90 (+104)	T6	T6	T6
CMLED15	+40 (+104)	+90 (+104)	T6	T6	T6
	+55 (+131)	+90 (+104)	T6	T6	T6
	+65 (+140)	+90 (+104)	T6	T6	T6
CMLED17	+40 (+104)	+90 (+104)	T6	T6	T6
	+55 (+131)	+90 (+104)	T6	T6	T6
	+65 (+140)	+90 (+104)	T5	T5	T5
CMLED25	+40 (+104)	+90 (+104)	T6	T6	T6
	+55 (+131)	+90 (+104)	T6	T6	T5
	+65 (+140)	+90 (+104)	T5	T5	T5
CMLED35	+40 (+104)	+90 (+104)	T6	T6	T6
	+55 (+131)	+90 (+104)	T5	T5	T75
	+65 (+140)	+90 (+104)	T5	T5	T4A
CMLED40	+40 (+104)	+90 (+104)	T6	T6	T6
	+55 (+131)	+90 (+104)	T5	T5	T5
	+65 (+140)	+90 (+104)	T4A	T4	T4A
CMLED75	+40 (+104)	+90 (+104)	T5	T5	T5
	+55 (+131)	+90 (+104)	T5	T5	T4A
	+65 (+140)	+90 (+104)	T4A	T4	T4A
CMLED90	+40 (+104)	+90 (+104)	T5	T5	T4A
	+55 (+131)	+90 (+104)	T4A	T4	T4A

“T” Numbers Represent the Maximum Surface Temperature for Class I, Division 1 locations and Maximum Surface Temperature Under Dust Blanket for Class II, Division 1 Locations. ② ③

“T” #	T1	350	325	T2	T2A	T2B	T2C	T2D	T3	T3A	T3B	T3C	T4	T4A	T5	T6
Temp. Range °C (°F)	+351 to +450 (+664 to +842)	+326 to +350 (+619 to +662)	+301 to +325 (+574 to +617)	+281 to +300 (+538 to +572)	+261 to +280 (+502 to +536)	+231 to +260 (+448 to +500)	+216 to +230 (+421 to +446)	+201 to +215 (+394 to +419)	+181 to +200 (+358 to +392)	+166 to +180 (+331 to +356)	+161 to +165 (+322 to +329)	+136 to +160 (+277 to +320)	+121 to +135 (+250 to +275)	+101 to +120 (+214 to +248)	+86 to +100 (+187 to +212)	+85 (+185)

① T-Codes are using the “APMS” drivers.

② T numbers represent the maximum internal temperature for Class I, Division 2 and Class I, Zone 2 locations designated by the NEC.

③ T numbers represent the maximum surface temperature under a dust blanket for Class II, Division 1 as designated by the NEC.

Note: Complete Code•Master LED luminaire consists of fixture unit and a mounting hood.

⌘ Use of a fuse voids Marine Outside Type (Salt Water) rating.

Code•Master™ LED Factory Sealed Luminaires





Explosionproof, Dust-Ignitionproof
Hazardous Locations.

NEC/CEC: Class I, Division 1 and 2, Groups B, C, D Ⓛ | Class I, Zone 1, Groups IIA, IIB, IIB + H₂ | Class II, Division 1, Group E, F, G | Class II, Division 2, Group F, G | Class III | Type 3R, 4X | IP66/67 | Simultaneous Exposure | Suitable for Use in Wet Locations | Marine Outside Type (Salt Water) ⌘ | Approved for use in Paint Spray Booths

Catalog Number for Driver Housing and Globe

	HID Equivalent	CCT	Optics	Weight in kg (lb)	Clear Globe ①②③④⑤	Diffused Globe ②③④⑤
	100W	5000K	Type V	17.2 (38)	CMLED10G5	CMLED10D5
	150W	5000K	Type V	17.2 (38)	CMLED15G5	CMLED15D5
	175W	5000K	Type V	17.2 (38)	CMLED17G5	CMLED17D5
	250W	5000K	Type V	17.2 (38)	CMLED25G5	CMLED25D5
	350W	5000K	Type V	17.2 (38)	CMLED35G5	CMLED35D5
	400W	5000K	Type V	17.2 (38)	CMLED40G5	CMLED40D5
	600W	5000K	Type V	17.2 (38)	CMLED75G5	CMLED75D5
	750W	5000K	Type V	17.2 (38)	CMLED90G5	CMLED90D5

Mounting Hoods

	Hub Size Inches	Certified for Class I, Division 1 and 2, Group cULus Certified	Weight in kg (lbs)	Catalog Number
Pendant — One Hub				
	3/4" NPT	B, C, D	0.80 (1.77)	CAP-75
	1" NPT	B, C, D	0.57 (1.25)	CAP-100
Ceiling — Four hubs, Three Close-Up Plugs				
	3/4" NPT	B, C, D	1.48 (3.26)	CAC-75
	1" NPT	B, C, D	1.40 (3.09)	CAC-100
Bracket — Four hubs, Three Close-Up Plugs				
	3/4" NPT	B, C, D	2.69 (5.92)	CALB-75
	1" NPT	B, C, D	2.72 (6.00)	CALB-100
25° Stanchion — One Hub				
	1-1/4" or 1-1/2" NPT Ⓣ	C, D	0.98 (2.16)	CAS-150
	1-1/2" NPT	B, C, D	3.74 (8.25)	CAS-150B Ⓢ

① For other lumen options, change the 6th and 7th digits in the part number. **10** for 3,700, **15** for 5,400, **17** for 7,900, **25** for 10,000, **35** for 11,600, **40** for 13,600, **75** for 16,700, or **90** for 19,300. Example: from 3,700 lumens **CMLED10G5** to 10,000 lumens **CMLED25G5**.

② For other CCT options, change the 8th digit in part number from "W" to "N" for Neutral 4000K CCT or remove the "W" for Cool 5000K CCT. Example: **CMLED10WG5** to "N" for 4000K, **CMLED10NG5**, or **CMLED10WG5** to **Blank** for 5000K, **CMLED10G5**.

③ To change from a NEMA Type V Symmetrical to a NEMA Type V Wide light distribution pattern, change the 9th digit in part number from "5" to "W". Example: **CMLED10DW**.

④ For 120-277 Vac, 50/60 Hz, add suffix **-BU** to catalog number. For 347-480 Vac, 50/60 Hz, add suffix **-BH** to catalog number. Example: **CMLED10G5BU**.

⑤ For fusing add "F" to end of catalog number. Example: **CMLED10G5BUF**.

⑥ Guards are available for fixtures with globe or refractor. See following pages for accessory ordering information.

⑦ 1-1/2" tapped hub furnished with 1-1/2" to 1-1/4" reducer.

⑧ When using the 25° Stanchion mounting hood in group B applications part number **CAS-150B** must be used.

Note: Complete Code•Master LED luminaire consists of fixture unit and a mounting hood.

⌘ Use of a fuse voids Marine Outside Type (Salt Water) rating.

LED Luminaires | Area / Task | Hazardous Location — Explosionproof | NEC / CEC







Code•Master™ LED Factory Sealed Luminaires

Explosionproof, Dust-Ignitionproof
Hazardous Locations.

NEC/CEC: Class I, Division 1 and 2, Groups B, C, D Ⓢ | Class I, Zone 1, Groups IIA, IIB, IIB + H₂ | Class II, Division 1, Group E, F, G | Class II, Division 2, Group F, G | Class III | Type 3R, 4X | IP66/67 | Simultaneous Exposure | Suitable for Use in Wet Locations | Marine Outside Type (Salt Water) ⌘ | Approved for use in Paint Spray Booths

LED Luminaires | Area / Task | Hazardous Location — Explosionproof | NEC / CEC

Accessories and Replacement Parts

	Description	Weight in kg (lbs)	Catalog Number
Fuse Kits ⌘			
	5 Amp Fuse Kit	0.32 (0.70)	CMLEDF5
Globes			
	Clear Globe Assembly	3.95 (8.70)	CGLCLEAR
	Diffused Globe Assembly	3.95 (8.70)	CGLDIFF
	Stainless Steel Wire Guard	0.16 (0.35)	CMLEDGU
	Safety Cable	0.81 (1.78)	CMLEDSC
	Yoke Bracket	2.82 (6.23)	CMLEDYOKE



Note: Complete Code•Master LED luminaire consists of fixture unit and a mounting hood.

⌘ Use of a fuse voids Marine Outside Type (Salt Water) rating.

Code•Master™ LED Factory Sealed Luminaires

Explosionproof, Dust-Ignitionproof
Hazardous Locations.

NEC/CEC: Class I, Division 1 and 2, Groups B, C, D Ⓛ | Class I, Zone 1, Groups IIA, IIB, IIB + H₂ | Class II, Division 1, Group E, F, G | Class II, Division 2, Group F, G | Class III | Type 3R, 4X | IP66/67 | Simultaneous Exposure | Suitable for Use in Wet Locations | Marine Outside Type (Salt Water) ⚠ | Approved for use in Paint Spray Booths

Replacement Drivers					
	Luminaire Model	Voltage ①	Driver Wattage	Constant Current Settings	Catalog Number
	CMLED10	BU	50 Watt	500mA	APMS050C135UD50
		BH			APMS050C135HD50
	CMLED15	BU	50 Watt	780mA	APMS050C135UD75
		BH			APMS050C135HD75
	CMLED17	BU	100 Watt	360mA	APMS100C105UD37
		BH			APMS100C105HD37
	CMLED25	BU	100 Watt	480mA	APMS100C105UD48
		BH			APMS100C105HD48
	CMLED35	BU	100 Watt	595mA	APMS100C105UD57
		BH			APMS100C105HD57
	CMLED40	BU	150 Watt	650mA	APMS150C105UD65
		BH			APMS150C105HD65
	CMLED75	BU	150 Watt	820mA	APMS150C105UD82
		BH			APMS150C105HD82
	CMLED90	BU	150 Watt	960mA	APMS150C105UD98
		BH			APMS150C105HD98

Replacement Drivers for fixtures without "Model A" marking on label		
	Description	Catalog Number
	120 - 277 V Driver (70 thru 250 Watt equivalent only)	CMLEDBU
	347 - 480 V Driver (70 thru 350 Watt equivalent only)	CMLEDBH
	120 - 277 V Driver (400 Watt equivalent only)	CMLEDBU40

Luminaire Weight	
Description	Weight in kg (lb)
Fixture Unit (Ballast Housing)	17.2 (38)

① BU = 120 - 277 Vac, 50/60 Hz or 125 - 300 Vdc; BU = 347 - 480, 50/60 Hz.
Note: Complete Code•Master LED luminaire consists of fixture unit and a mounting hood.
⚠ Use of a fuse voids Marine Outside Type (Salt Water) rating.

LED Luminaires | Area / Task | Hazardous Location — Explosionproof | NEC / CEC

Code•Master™ LED Factory Sealed Luminaires

Explosionproof, Dust-Ignitionproof
Hazardous Locations.

NEC/CEC: Class I, Division 1 and 2, Groups B, C, D Ⓢ | Class I, Zone 1, Groups IIA, IIB, IIB + H₂ | Class II, Division 1, Group E, F, G | Class II, Division 2, Group F, G | Class III | Type 3R, 4X | IP66/67 | Simultaneous Exposure | Suitable for Use in Wet Locations | Marine Outside Type (Salt Water) ⚡ | Approved for use in Paint Spray Booths

LED Luminaires | Area / Task | Hazardous Location — Explosionproof | NEC / CEC

Dimensions in Millimeters (Inches)

Pendant

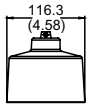

Ceiling

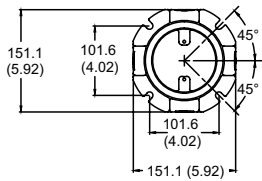

Bracket

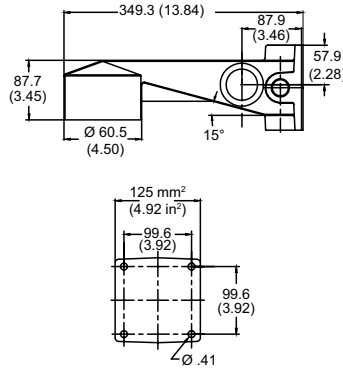

25° Stanchion

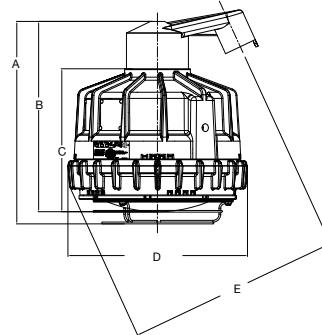
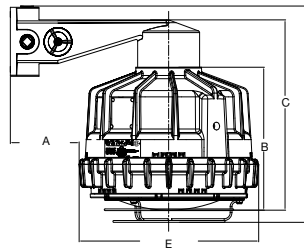
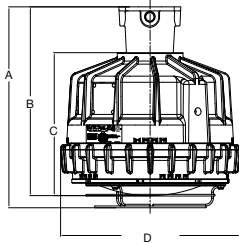
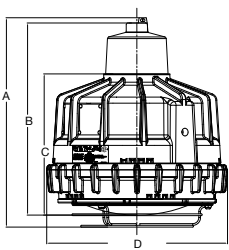
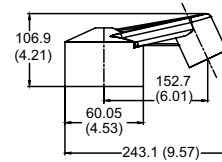

Pendant				Ceiling				Bracket				25° Stanchion					
A	B	C	D	A	B	C	D	A	B	C	D	E	A	B	C	D	E
384.0	352.0	259.0	331.0	364.0	342.0	259.0	331.0	127.0	259.0	344.0	391.0	331.0	366.0	344.0	259.0	331.0	392.0
(15.1)	(13.9)	(10.2)	(13.0)	(14.3)	(13.5)	(10.2)	(13.0)	(5.0)	(10.2)	(13.6)	(15.4)	(13.0)	(14.4)	(13.6)	(10.2)	(13.0)	(15.4)

Wire Guard

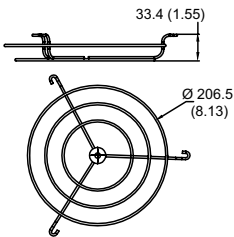

Yoke Mount

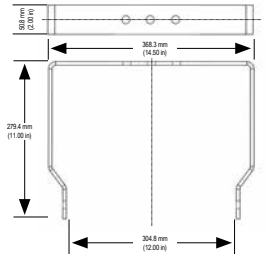

Note: Complete Code•Master LED luminaire consists of fixture unit and a mounting hood.
⚡ Use of a fuse voids Marine Outside Type (Salt Water) rating.

Code•Master™ LED Factory Sealed Luminaires

Explosionproof, Dust-Ignitionproof
Hazardous Locations.

NEC/CEC: Class I, Division 1 and 2, Groups B, C, D Ⓢ | Class I, Zone 1, Groups IIA, IIB, IIB + H₂ | Class II, Division 1, Group E, F, G | Class II, Division 2, Group F, G | Class III | Type 3R, 4X | IP66/67 | Simultaneous Exposure | Suitable for Use in Wet Locations | Marine Outside Type (Salt Water) ⌘ | Approved for use in Paint Spray Booths

Photometric Data — DATA SHOWN IS ABSOLUTE

Type V, Clear Glass, 5000K CCT
REPORT NUMBER: CMLED10G5BU

POLAR CANDELA DISTRIBUTION

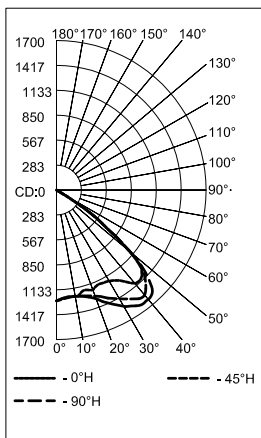

ISOFOOT CANDLE PLOT

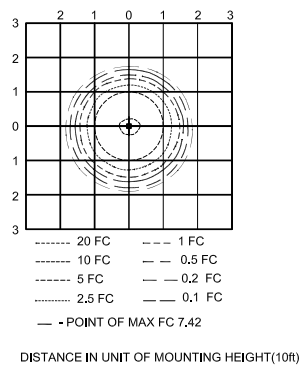

ZONAL LUMEN SUMMARY

Zone	Lumens	% Luminaire
0-30	1,090.3	29.2%
0-40	2,043.9	54.7%
0-60	3,677.9	98.3%
60-90	60.4	1.6%
70-100	10.9	0.3%
90-120	0.2	0%
0-90	3,738.2	100%
90-180	1.5	0%
0-180	3,739.8	100%

LUMENS PER ZONE

Zone	Lumens	% Total	Zone	Lumens	% Total
0-10	116.4	3.1%	90-100	0.2	0
10-20	349.9	9.4%	100-110	0	0
20-30	624.0	16.7%	110-120	0	0
30-40	953.5	25.5%	120-130	0	0
40-50	1,102.0	29.5%	130-140	0.2	0
50-60	532.0	14.2%	140-150	0.5	0
60-70	49.6	1.3%	150-160	0.4	0
70-80	8.5	0.2%	160-170	0.2	0
80-90	2.2	0.1%	170-180	0.1	0

Type V, Clear Glass, 5000K CCT
REPORT NUMBER: CMLED15G5BU

POLAR CANDELA DISTRIBUTION

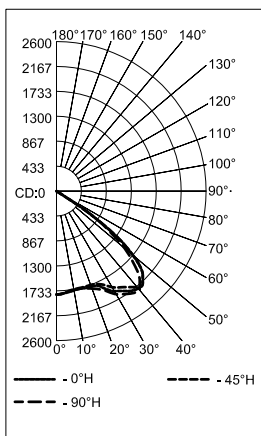

ISOFOOT CANDLE PLOT

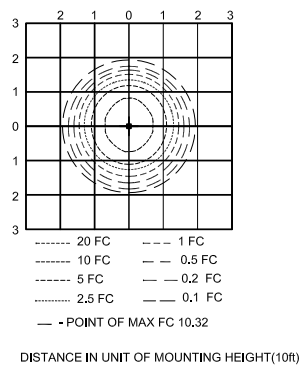

ZONAL LUMEN SUMMARY

Zone	Lumens	% Luminaire
0-30	1,573.4	29.3%
0-40	2,948.7	54.9%
0-60	5,289.7	98.4%
60-90	83.0	1.5%
70-100	14.2	0.3%
90-120	0.3	0%
0-90	5,372.7	100%
90-180	2.2	0%
0-180	5,374.9	100%

LUMENS PER ZONE

Zone	Lumens	% Total	Zone	Lumens	% Total
0-10	167.6	3.1%	90-100	0.3	0
10-20	504.2	9.4%	100-110	0	0
20-30	901.6	16.8%	110-120	0	0
30-40	1,375.2	25.6%	120-130	0.1	0
40-50	1,584.4	29.5%	130-140	0.6	0
50-60	756.7	14.1%	140-150	0.5	0
60-70	69.1	1.3%	150-160	0.4	0
70-80	11.2	0.2%	160-170	0.3	0
80-90	2.7	0.1%	170-180	0.1	0

Note: Complete Code•Master LED luminaire consists of fixture unit and a mounting hood.
⌘ Use of a fuse voids Marine Outside Type (Salt Water) rating.

Code•Master™ LED Factory Sealed Luminaires

Explosionproof, Dust-Ignitionproof

Hazardous Locations.

NEC/CEC: Class I, Division 1 and 2, Groups B, C, D Ⓢ | Class I, Zone 1, Groups IIA, IIB, IIB + H₂ | Class II, Division 1, Group E, F, G | Class II, Division 2, Group F, G | Class III | Type 3R, 4X | IP66/67 | Simultaneous Exposure | Suitable for Use in Wet Locations | Marine Outside Type (Salt Water) ⌘ | Approved for use in Paint Spray Booths

Photometric Data — DATA SHOWN IS ABSOLUTE

Type V, Clear Glass, 5000K CCT
REPORT NUMBER: CMLED17G5BU

POLAR CANDELA DISTRIBUTION

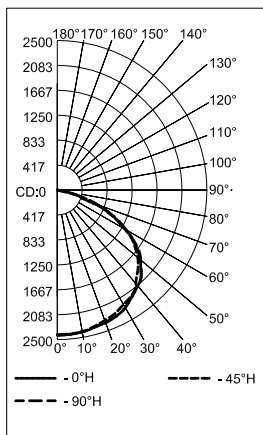

ISOFOOT CANDLE PLOT

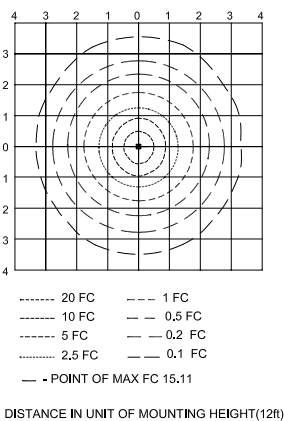

ZONAL LUMEN SUMMARY

Zone	Lumens	% Luminaire
0-30	1,959.3	24.8%
0-40	3,313.1	42%
0-60	6,266.9	79.4%
60-90	1,620.6	20.5%
70-100	560.1	7.1%
90-120	1.0	0%
0-90	7,887.5	100%
90-180	3.2	0%
0-180	7,890.7	100%

LUMENS PER ZONE

Zone	Lumens	% Total	Zone	Lumens	% Total
0-10	116.4	3.1%	90-100	0.2	0
10-20	349.9	9.4%	100-110	0	0
20-30	624.0	16.7%	110-120	0	0
30-40	953.5	25.5%	120-130	0	0
40-50	1,102.0	29.5%	130-140	0.2	0
50-60	532.0	14.2%	140-150	0.5	0
60-70	49.6	1.3%	150-160	0.4	0
70-80	8.5	0.2%	160-170	0.2	0
80-90	2.2	0.1%	170-180	0.1	0

Type V, Clear Glass, 5000K CCT
REPORT NUMBER: CMLED25G5BU

POLAR CANDELA DISTRIBUTION

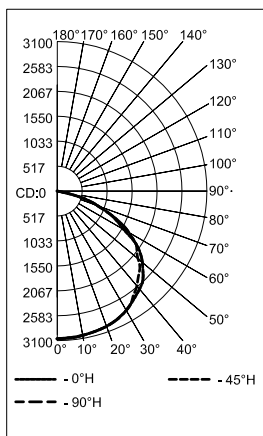

ISOFOOT CANDLE PLOT

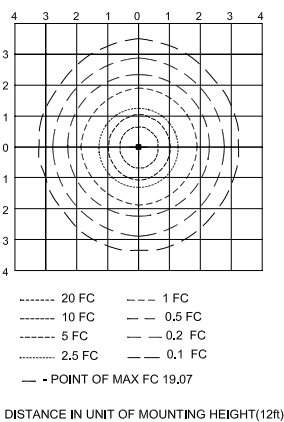

ZONAL LUMEN SUMMARY

Zone	Lumens	% Luminaire
0-30	2,482.0	24.9%
0-40	4,197.1	42.1%
0-60	7,931.9	79.6%
60-90	2,033.5	20.4%
70-100	696.8	7%
90-120	1.3	0%
0-90	9,965.4	100%
90-180	4.0	0%
0-180	9,969.4	100%

LUMENS PER ZONE

Zone	Lumens	% Total	Zone	Lumens	% Total
0-10	289.4	2.9%	90-100	1.2	0
10-20	847.5	8.5%	100-110	0.1	0
20-30	1,345.1	13.5%	110-120	0.0	0
30-40	1,715.1	17.2%	120-130	0.4	0
40-50	1,912.2	19.2%	130-140	0.8	0
50-60	1,822.5	18.3%	140-150	0.6	0
60-70	1,337.9	13.4%	150-160	0.5	0
70-80	632.0	6.3%	160-170	0.3	0
80-90	63.6	0.6%	170-180	0.2	0

Note: Complete Code•Master LED luminaire consists of fixture unit and a mounting hood.
⌘ Use of a fuse voids Marine Outside Type (Salt Water) rating.

Code•Master™ LED Factory Sealed Luminaires

Explosionproof, Dust-Ignitionproof
Hazardous Locations.

NEC/CEC: Class I, Division 1 and 2, Groups B, C, D Ⓢ | Class I, Zone 1, Groups IIA, IIB, IIB + H₂ | Class II, Division 1, Group E, F, G | Class II, Division 2, Group F, G | Class III | Type 3R, 4X | IP66/67 | Simultaneous Exposure | Suitable for Use in Wet Locations | Marine Outside Type (Salt Water) Ⓢ | Approved for use in Paint Spray Booths

Photometric Data — DATA SHOWN IS ABSOLUTE

Type V, Clear Glass, 5000K CCT

REPORT NUMBER: CMLED35G5BU

POLAR CANDELA DISTRIBUTION

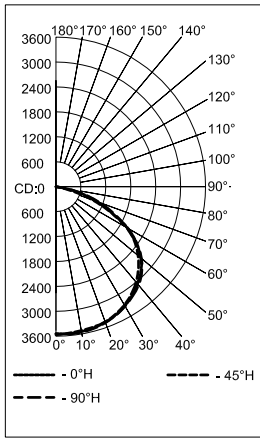

ISOFOOT CANDLE PLOT

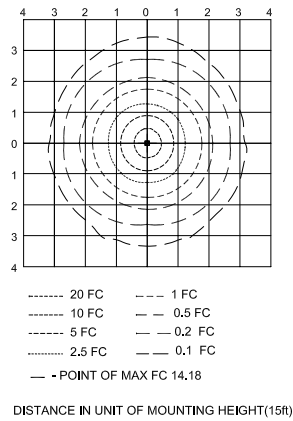

ZONAL LUMEN SUMMARY

Zone	Lumens	% Luminaire
0-30	2,894.8	24.9%
0-40	4,897.1	42.1%
0-60	9,259.1	79.6%
60-90	2,372.4	20.4%
70-100	816.1	7%
90-120	3.4	0%
0-90	11,631.6	99.9%
90-180	7.7	0.1%
0-180	11,639.3	100%

LUMENS PER ZONE

Zone	Lumens	% Total	Zone	Lumens	% Total
0-10	337.3	2.9%	90-100	1.6	0
10-20	988.8	8.5%	100-110	0.8	0
20-30	1,568.7	13.5%	110-120	0.9	0
30-40	2,002.3	17.2%	120-130	0.9	0
40-50	2,232.9	19.2%	130-140	0.8	0
50-60	2,129.2	18.3%	140-150	0.9	0
60-70	1,557.9	13.4%	150-160	0.9	0
70-80	738.7	6.3%	160-170	0.6	0
80-90	75.8	0.7%	170-180	0.2	0

Type V, Clear Glass, 5000K CCT

REPORT NUMBER: CMLED40G5BU

POLAR CANDELA DISTRIBUTION

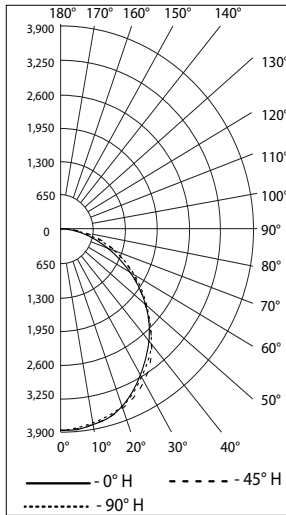

ISOFOOT CANDLE PLOT

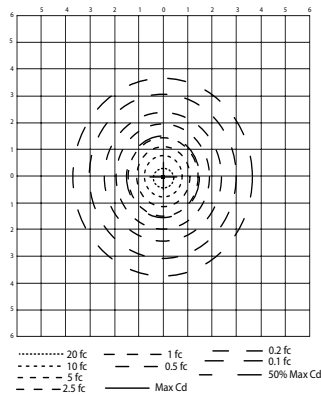

ZONAL LUMEN SUMMARY

Zone	Lumens	% Luminaire
0-30	3,441.9	25.4
0-40	5,808.0	42.8
0-60	10,874.3	80.2
60-90	2,681.4	19.8
70-100	917.3	6.8
90-120	4.0	0
0-90	13,555.6	99.9
90-180	7.2	0.1
0-180	13,562.9	100

LUMENS PER ZONE

Zone	Lumens	% Total
0-10	402.3	3.0
10-20	1,179.4	8.7
20-30	1,860.2	13.7
30-40	2,366.1	17.4
40-50	2,609.2	19.2
50-60	2,457.1	18.1
60-70	1,766.8	13.0
70-80	821.2	6.1
80-90	93.4	0.7
90-100	2.6	0
100-110	0.7	0

Note: Complete Code•Master LED luminaire consists of fixture unit and a mounting hood.

Ⓢ Use of a fuse voids Marine Outside Type (Salt Water) rating.

Code•Master™ LED Factory Sealed Luminaires

Explosionproof, Dust-Ignitionproof
Hazardous Locations.

NEC/CEC: Class I, Division 1 and 2, Groups B, C, D Ⓛ | Class I, Zone 1, Groups IIA, IIB, IIB + H₂ | Class II, Division 1, Group E, F, G | Class II, Division 2, Group F, G | Class III | Type 3R, 4X | IP66/67 | Simultaneous Exposure | Suitable for Use in Wet Locations | Marine Outside Type (Salt Water) ⚠ | Approved for use in Paint Spray Booths

Photometric Data — DATA SHOWN IS ABSOLUTE

Type V, Clear Glass, 5000K CCT
REPORT NUMBER: CMLED75G5BU

POLAR CANDELA DISTRIBUTION

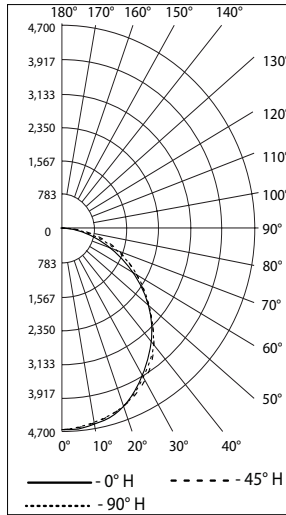

ISOFOOT CANDLE PLOT

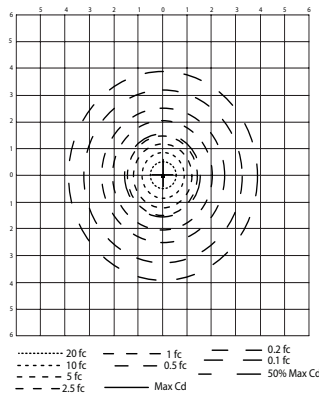

ZONAL LUMEN SUMMARY

Zone	Lumens	% Luminaire
0-30	4,249.2	25.4
0-40	7,168.9	42.9
0-60	13,411.1	80.2
60-90	3,295.9	19.7
70-100	1,127.6	6.7
90-120	4.7	0
0-90	16,707.0	99.9
90-180	8.8	0.1
0-180	16,715.8	100.0

LUMENS PER ZONE

Zone	Lumens	% Total
0-10	496.7	3.0
10-20	1,456.1	8.7
20-30	2,296.4	13.7
30-40	2,919.7	17.5
40-50	3,217.1	19.2
50-60	3,025.1	18.1
60-70	2,171.4	13.0
70-80	1,009.8	6.0
80-90	114.7	0.7
90-100	3.2	0
100-110	0.8	0

Type V, Clear Glass, 5000K CCT
REPORT NUMBER: CMLED90G5BU

POLAR CANDELA DISTRIBUTION

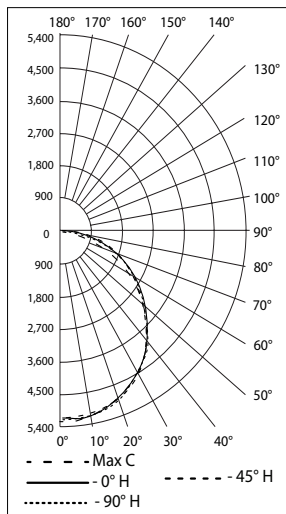

ISOFOOT CANDLE PLOT

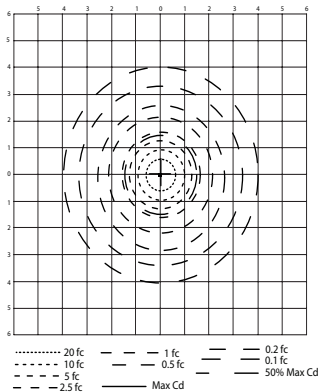

ZONAL LUMEN SUMMARY

Zone	Lumens	% Luminaire
0-30	4,927.2	25.4
0-40	8,295.2	42.9
0-60	15,516.1	80.2
60-90	3,810.1	19.7
70-100	1,302.8	6.7
90-120	5.7	0
0-90	19,326.2	99.9
90-180	10.3	0.1
0-180	19,337.0	100

LUMENS PER ZONE

Zone	Lumens	% Total
0-10	574.8	3.0
10-20	1,685.1	8.7
20-30	2,657.3	13.7
30-40	3,378.0	17.5
40-50	3,721.6	19.2
50-60	3,499.3	18.1
60-70	2,511.0	13.0
70-80	1,165.7	6.0
80-90	133.5	0.7
90-100	3.7	0
100-110	1.0	0

Note: Complete Code•Master LED luminaire consists of fixture unit and a mounting hood.
⚠ Use of a fuse voids Marine Outside Type (Salt Water) rating.