

Contender™ LED Series Luminaires

Enclosed and Gasketed Fixtures — Hazardous Locations

NEC/CEC: Class I, Division 2, Groups A,B,C,D | Class I, Zone 2, AEx ec IIC Ⓢ | Class II, Division 1, Groups E,F,G | Zone 21, AEx tb IIC Ⓢ | Class II, Division 2, Groups F,G | Class III | Type 3R, 4, 4X | IP66/67 | Simultaneous Exposure | Suitable for Use in Wet Locations | Marine Outside Type (Salt Water)
 Notable: American Bureau of Shipping (ABS) Certified | International Dark Sky (IDA) Approved

Applications

- Enclosed and gasketed fixtures suitable for use in:
 - A wide range of industrial, chemical processing and other areas where flammable gases, vapors and combustible dusts and fibers are present including simultaneous exposure
 - Marine and wet locations
 - Areas of low clearance, low ceiling heights or where fixture weights must be minimized
- Typical industries include:
 - Pulp and paper mills
 - Processing plants
 - Chemical plants
 - Petrochemical facilities
 - Oil refineries
 - Drilling rigs
 - Foundries
 - Waste treatment
 - Mining
 - Steel mills
 - Hydrogen and Biofuels plants
 - LNG (Liquid Natural Gas) plants
- Typical applications include:
 - Walkways/catwalks/stairwells
 - Grain elevators
 - Tunnels
 - Pipe racks
 - Offshore rigs
 - Vessel lighting
 - Cooling towers
 - Processing areas

Features

- Mounts directly to the following Crouse Hinds™ + Champ® + VMV mounting hoods.

Mounting Hoods	Model
Pendant	APM2, APM3
Flexible Pendant	HPM2
Ceiling	CM2, CM3
Wall	TWM2, TWM3
Quad	QM25
25° Stanchion	JM5
Straight Stanchion	PM5

- Compact light weight low profile design is suited for low mounting heights (less than 5.44 kg. [12 lbs]).
- Customize to the application requirements with four different field replaceable globe options: clear and diffused polycarbonate, clear glass, or prismatic glass refractor.
- Three Correlated Color Temperatures (CCTs) for a wide variety of applications: Cool (5000K), Neutral (4000K) and Warm (3000K)
- Three light output levels for retrofit of HID fixtures up to 175 W.

Nominal Lumens ②	HID Equivalent	Model
3300	70-100W	VMV3LCG5BU
4400	100-150W	VMV4LCG5BU
5500	150-175W	VMV5LCG5BU

① AEx rating is only applicable to product configurations with terminal block wiring option.

② Nominal Lumen value for 5000K CCT, clear glass globe. Detailed lumen information is provided in the "Lumen Output (Efficacy)" tables.

+ Crouse-Hinds and Champ are registered trademarks of Cooper Crouse-Hinds.



With Clear Plastic Globe



With Short Prismatic Glass Refractor

- Standard 6 kV/3 kA surge protection.
- Ambient Temperature: BU: -40 °C to +65 °C (-40 °F to +149 °F); BH: -40 °C up to +65 °C (-40 °F up to +149 °F).
- Heavy duty, high temperature silicone rubber gaskets.
- Reported L70 is >108,000.
- Field replaceable globes and IP66 rated LED driver.
- Rugged housing with superior thermal design translates to long luminaire life.
- Luminaire comes pre-wired with three conductors, approximately 304.8 mm (12" long), of 14 AWG TEW wire from the IP68 watertight NPT hub at the top of the luminaire lid.
- Product can be configured with wirenuts or screw terminal blocks for ease of wiring.
- Photometric data and electronic drawings available upon request.
- 5 year standard warranty.

Options

- Glass and Polycarbonate globe and glass refractor guards available, purchase separately.

Standard Materials

- Luminaire body: cast copperfree (4/10 of 1% max.) aluminum
- All hardware: stainless steel
- Globe: polycarbonate or glass
- Glass refractor guard: stainless steel wire
- Globe guard, short refractor guard and safety cable: stainless steel wire
- Reflector: fiberglass reinforced white polyester
- Visor: aluminum
- Gasket: silicone rubber

Standard Finishes

- Luminaire bodies, glass refractor guard and visor: gray epoxy powder coat finish, electrostatically applied for complete uniform protection

NEC/CEC Certifications and Compliances

- UL Standard: UL 50E (2nd Ed.); UL 844 (13th Ed.); UL 1598 (3rd Ed.); UL 1598A (1st Ed.); UL 8750 (2nd Ed.)
- CSA Standard: C22.2 No 0-10; C22.2 No. 94.2-15; C22.2 No. E60598-1:16; C22.2 No. 137-M1981; C22.2 No. 250.0-08; C22.2 No. 250.13-14; C22.2 No. 60529:16
- cCSAus Listed: Master contract 164460; Certificate Number 70170001

ABS Certifications

- VMV: 18-HS1741303-PDA

International Dark-Sky Association

- IDA Dark-Sky Approved when ordering VMV[3L/4L/5L]W[P5/D5/G5]xxx with MMVISOR accessory (3000K CCT).

DesignLights™ Consortium

- Check DLC QPL for current list of products.

Contender™ LED Series Luminaires

Enclosed and Gasketed Fixtures — Hazardous Locations

NEC/CEC: Class I, Division 2, Groups A,B,C,D | Class I, Zone 2, AEx ec IIC Ⓞ | Class II, Division 1, Groups E,F,G | Zone 21, AEx tb IIC Ⓞ | Class II, Division 2, Groups F,G | Class III | Type 3R, 4, 4X | IP66/67 | Simultaneous Exposure | Suitable for Use in Wet Locations | Marine Outside Type (Salt Water)
Notable: American Bureau of Shipping (ABS) Certified | International Dark Sky (IDA) Approved

LED Luminaires | Area / Task | Hazardous Location | NEC / CEC

Illustrated Features



Wiring Flexibility

Choose between wire nuts and screw terminal blocks to suit end user wiring preferences. Terminal blocks support UL/CSA 24 to 12 AWG wire.



Globe Gaskets

Silicone rubber gaskets seal out moisture, dirt and dust. Stays flexible, withstands extreme temperatures. Closure design assures uniform gasket compression.



Watertight

Watertight IP68 rated bushing where cord enters luminaire hood ensures no water will enter the luminaire from the conduit through the mounting hood.



Prismatic Refractor

Heat-resistant refractor threads directly into fixture housing and seal against a high-temperature silicone rubber gasket.



Angled Reflector and Visor

Angled reflector is thick, tough fiberglass reinforced white polyester. Visor is aluminum with electrostatically applied, gray epoxy powder coat finish. Quickly attach either accessory to luminaire with furnished stainless steel screws.



“Safety” Cable

Safety cable option threads through the fixture housing for additional safety.

Heatsink: Reliable heat transfer via the cast, epoxy powder coat aluminum body. Provides maximum heat dissipation from the LED assembly to the outside environment.

Driver Assembly: IP66 rated driver utilizes non-sparking components avoiding the ignition of gases or vapors that may be present.

Electrical Protection: External Grounding provisions for additional safety.

Epoxy Finish: Fixture housing, hoods and guards are copperfree aluminum with triple protection epoxy powder coat finish.

Ⓞ AEx rating is only applicable to product configurations with terminal block wiring option

Contender™ LED Series Luminaires

Enclosed and Gasketed Fixtures — Hazardous Locations

NEC/CEC: Class I, Division 2, Groups A,B,C,D | Class I, Zone 2, AEx ec IIC Ⓢ | Class II, Division 1, Groups E,F,G | Zone 21, AEx tb IIC Ⓢ | Class II, Division 2, Groups F,G | Class III | Type 3R, 4, 4X | IP66/67 | Simultaneous Exposure | Suitable for Use in Wet Locations | Marine Outside Type (Salt Water)
 Notable: American Bureau of Shipping (ABS) Certified | International Dark Sky (IDA) Approved

Contender™ LED Family Tree

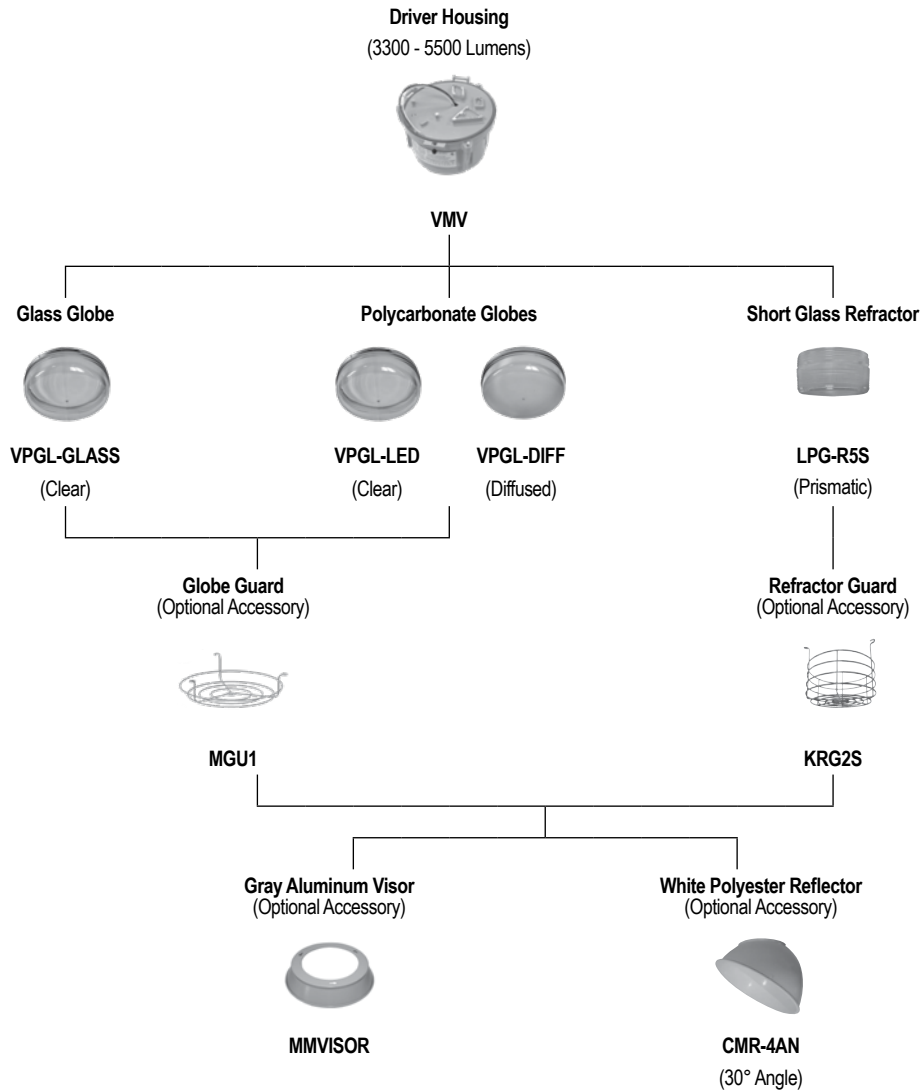

Ⓢ AEx rating is only applicable to product configurations with terminal block wiring option.

Contender™ LED Series Luminaires

Enclosed and Gasketed Fixtures — Hazardous Locations

NEC/CEC: Class I, Division 2, Groups A,B,C,D | Class I, Zone 2, AEx ec IIC ① | Class II, Division 1, Groups E,F,G | Zone 21, AEx tb IIC ① | Class II, Division 2, Groups F,G | Class III | Type 3R, 4, 4X | IP66/67 | Simultaneous Exposure | Suitable for Use in Wet Locations | Marine Outside Type (Salt Water)
 Notable: American Bureau of Shipping (ABS) Certified | International Dark Sky (IDA) Approved

LED Luminaires | Area / Task | Hazardous Location | NEC / CEC

Order Using Catalog Numbering Guide — Contender™ LED Series Luminaires

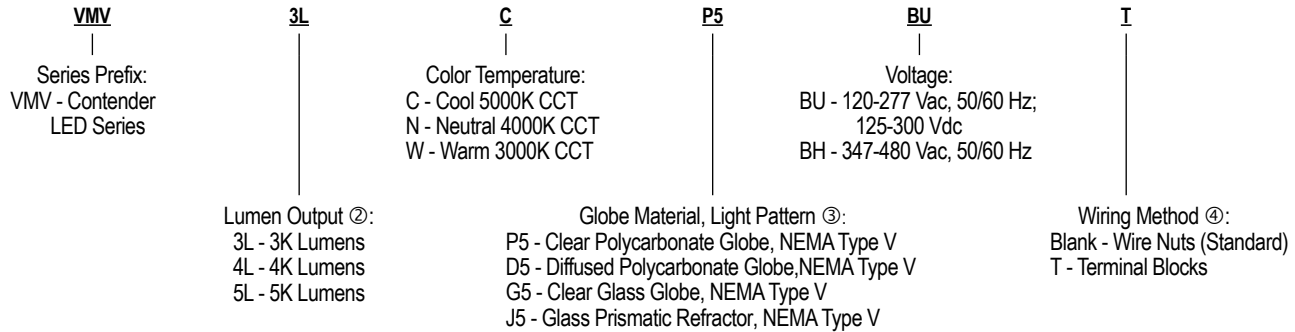

Lumen Output (Efficacy) ⑤

Model	HID Equivalency	Light Distribution Pattern	CCT (Correlated Color Temperature)	CRI (Color Rendering Index)	Lumen Output	Efficacy (lm/W)	CCT	CRI	Lumen Output	Efficacy (lm/W)	CCT	CRI	Lumen Output	Efficacy (lm/W)
Clear Polycarbonate Globe														
VMV3L	70-100W		3000K	>70	3000	107	4000K	>70	3000	107	5000K	>70	3200	114
VMV4L	100-150W	Type V	3000K	>70	3900	102	4000K	>70	4000	105	5000K	>70	4200	110
VMV5L	150-175W		3000K	>70	4900	102	4000K	>70	5000	104	5000K	>70	5300	110
Diffused Polycarbonate Globe ⑥														
VMV3L	70-100W		3000K	>70	2900	103	4000K	>70	2900	103	5000K	>70	3100	110
VMV4L	100-150W	Type V	3000K	>70	3800	100	4000K	>70	3900	102	5000K	>70	4100	107
VMV5L	150-175W		3000K	>70	4800	100	4000K	>70	4900	102	5000K	>70	5150	107
Clear Glass Globe														
VMV3L	70-100W		3000K	>70	3100	110	4000K	>70	3100	110	5000K	>70	3300	117
VMV4L	100-150W	Type V	3000K	>70	4100	107	4000K	>70	4200	110	5000K	>70	4400	115
VMV5L	150-175W		3000K	>70	5100	106	4000K	>70	5200	108	5000K	>70	5500	114
Glass Prismatic Refractor														
VMV3L	70-100W		3000K	>70	2800	100	4000K	>70	2800	100	5000K	>70	3000	107
VMV4L	100-150W	Type V	3000K	>70	3700	97	4000K	>70	3800	100	5000K	>70	4000	105
VMV5L	150-175W		3000K	>70	4600	96	4000K	>70	4650	97	5000K	>70	4900	102

① AEx rating is only applicable to product configurations with terminal block wiring option.
 ② For specific lumen output information, see Lumen Output table.
 ③ Guards for the glass refractor and globes are ordered separately. See the Accessories section for more information.
 ④ Terminal block wiring option is only available with BU voltage configuration.
 ⑤ All lumen values are typical (tolerance +/- 10%).
 ⑥ 70 minimum.

Contender™ LED Series Luminaires

Enclosed and Gasketed Fixtures — Hazardous Locations

NEC/CEC: Class I, Division 2, Groups A,B,C,D | Class I, Zone 2, AEx ec IIC Ⓛ | Class II, Division 1, Groups E,F,G | Zone 21, AEx tb IIC Ⓛ | Class II, Division 2, Groups F,G | Class III | Type 3R, 4, 4X | IP66/67 | Simultaneous Exposure | Suitable for Use in Wet Locations | Marine Outside Type (Salt Water)
 Notable: American Bureau of Shipping (ABS) Certified | International Dark Sky (IDA) Approved

LED Luminaires | Area / Task | Hazardous Location | NEC / CEC

Electrical Specifications ②

Model	Voltage	Input Power (Watts)	Input Current (Amps)	Power Factor (PF)	Total Harmonic Distortion (THD)
VMV3L	120 Vac	28.0	.28	> .94	< 20%
	277 Vac	28.0	.13		
	125 Vdc	27.2	.24	—	
	300 Vdc	27.2	.09		
	347 Vac	29.7	.10		
VMV4L	480 Vac	29.8	.06	> .93	
	120 Vac	38.0	.38	> .96	
	277 Vac	38.0	.16		
	125 Vdc	37.4	.32	—	
	300 Vdc	39.0	.13		
347 Vac	39.6	.13			
VMV5L	480 Vac	39.7	.08	> .96	
	120 Vac	48.0	.48	> .97	
	277 Vac	48.0	.20		
	125 Vdc	50.2	.40	—	
	300 Vdc	48.0	.16		
347 Vac	50.5	.16			
	480 Vac	50.4	.10	> .97	

NEC/CEC Temperature Codes

Model	Max Driver Current (mA)	Max Ambient C° (F°)	Gas		Dust			Gas/Dust
			Class I, Division 2 Groups A, B, C, D ③	Class I, Zone 2 Group AEx ec IIC	Class II, Division 1, Groups E, F, G ④	Zone 20, Group III C,	Zone 21, AEx tb IIC	Simultaneous ③ Class I, Division 2 / Class II, Division 1
VMV3L	40 (104)	T4A	T4	T6	T6	T85°C	T4A	T5
	55 (131)	T4	T4	T6	T6	T85°C	T4	T4
	65 (149)	T4	T4	T5	T5	T100°C	T4	T4
VMV4L	40 (104)	T4A	T4	T6	T6	T85°C	T4A	T4
	55 (131)	T4	T4	T6	T6	T85°C	T4	T3
	65 (149)	T4	T4	T5	T5	T100°C	T4	T3
VMV5L	40 (104)	T4A	T4	T6	T6	T85°C	T4A	T3
	55 (131)	T4	T4	T6	T6	T85°C	T4	T3
	65 (149)	T4	T4	T5	T5	T100°C	T4	T3

NEC/CEC — “T” Numbers Represent the Maximum Internal Temperature or Maximum Surface Temperature ③ ④

“T” #	T1	350	325	T2	T2A	T2B	T2C	T2D	T3	T3A	T3B	T3C	T4	T4A	T5	T6
Temp. Range C° (°F)	+351 to +450 (+664 to +842)	+326 to +350 (+619 to +662)	+301 to +325 (+574 to +617)	+281 to +300 (+538 to +572)	+261 to +280 (+502 to +536)	+231 to +260 (+448 to +500)	+216 to +230 (+421 to +446)	+201 to +215 (+394 to +419)	+181 to +200 (+358 to +392)	+166 to +180 (+331 to +356)	+161 to +165 (+322 to +329)	+136 to +160 (+277 to +320)	+121 to +135 (+250 to +275)	+101 to +120 (+214 to +248)	+86 to +100 (+187 to +212)	+85 (+185)

Note: Supply Wire Temperature for all: +90 °C (+194 °F).

① AEx rating is only applicable to product configurations with terminal block wiring option.

② All values are typical (tolerance +/-10%).

③ T numbers represent the maximum internal temperature for Class I, Division 2 and Class I, Zone 2 locations designated by the NEC.

④ T numbers represent the maximum surface temperature under a dust blanket for Class II, Division 1 as designated by the NEC.

Contender™ LED Series Luminaires

Enclosed and Gasketed Fixtures — Hazardous Locations

NEC/CEC: Class I, Division 2, Groups A,B,C,D | Class I, Zone 2, AEx ec IIC Ⓢ | Class II, Division 1, Groups E,F,G | Zone 21, AEx tb IIC Ⓢ | Class II, Division 2, Groups F,G | Class III | Type 3R, 4, 4X | IP66/67 | Simultaneous Exposure | Suitable for Use in Wet Locations | Marine Outside Type (Salt Water)
 Notable: American Bureau of Shipping (ABS) Certified | International Dark Sky (IDA) Approved





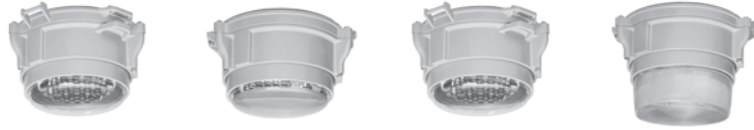



LED Luminaires | Area / Task | Hazardous Location | NEC / CEC

Fixture Unit — Driver Housing and Globe or Refractor

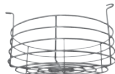

Lumen Level	LED Wattage	Light Level Equivalent	NEMA Type	Catalog Number			
				Polycarbonate Clear Globe ②③④	Polycarbonate Diffused Globe ②③④	Glass Globe ②③④	With Type V Glass Refractor ②③④
Driver Housing							
3K	28	70-100W HPS	Type V	VMV3LCP5	VMV3LCD5	VMV3LCG5	VMV3LCJ5
4K	38	100-150W HPS	Type V	VMV4LCP5	VMV4LCD5	VMV4LCG5	VMV4LCJ5
5K	48	150-175W HPS	Type V	VMV5LCP5	VMV5LCD5	VMV5LCG5	VMV5LCJ5

Accessories and Replacement Parts

	Description	Weight in kg (lbs)	Catalog Number
Globes			
	Clear Globe — Polycarbonate	0.2 (0.5)	VPGL-LED
	Diffused Globe — Polycarbonate	0.2 (0.5)	VPGL-DIFF
	Clear Globe — Glass	0.9 (1.9)	VPGL-GLASS
Light Distribution			
Prismatic Glass Refractor — All Heat-Resistant			
	Short Prismatic Glass Refractor — NEMA Type V	1.7 (3.7)	LPG-R5S
Guards			
	Globe Guard	0.2 (0.4)	MGU1
	Short Refractor Guard for LPG-R5S	0.3 (0.7)	KRG2S
Reflector			
	30° Angle White Polyester Reflectors	1.3 (2.7)	CMR-4AN
Visor			
	Electrostatically applied gray epoxy powder coat finish on Aluminum Visor	0.4 (0.9)	MMVISOR
Safety Cable			
	Stainless steel	0.2 (0.4)	LEDSC

① AEx rating is only applicable to product configurations with terminal block wiring option
 ② For 120-277 Vac, use suffix **-BU**. For 347-480 Vac, use suffix **-BH**.
 ③ Guards are available for fixtures with glass globe or refractor. See Accessories and Replacement Parts table for ordering information.
 ④ Correlated Color Temperature (CCT) indicated by C, N or W; C = Cool, 5000K CCT, N = Neutral, 4000K CCT, W = Warm, 3000K CCT. Example: **VMV5LCD5BU**.

Contender™ LED Series Luminaires

Enclosed and Gasketed Fixtures — Hazardous Locations

NEC/CEC: Class I, Division 2, Groups A,B,C,D | Class I, Zone 2, AEx ec IIC Ⓢ | Class II, Division 1, Groups E,F,G | Zone 21, AEx tb IIC Ⓢ | Class II, Division 2, Groups F,G | Class III | Type 3R, 4, 4X | IP66/67 | Simultaneous Exposure | Suitable for Use in Wet Locations | Marine Outside Type (Salt Water)
 Notable: American Bureau of Shipping (ABS) Certified | International Dark Sky (IDA) Approved

Replacement Drivers

	Model	Voltage	Driver Wattage	Constant Current Settings	Catalog Number
	VMV3L	BU	50 Watt	720mA	APMS050C135UD72
		BH		720mA	APMS050C135HD72
	VMV4L	BU	50 Watt	1000mA	APMS050C135UD10
		BH		1000mA	APMS050C135HD10
	VMV5L	BU	50 Watt	1300mA	APMS050C135UD13
		BH		1300mA	APMS050C135HD13

Luminaire Weights

Description	Weight kg (lb)
Fixture Unit with Polycarbonate Clear Globe	5.3 (11.8)
Fixture Unit with Polycarbonate Diffused Globe	5.3 (11.8)
Fixture Unit with Polycarbonate Glass Globe	5.9 (13.0)
Fixture Unit with Short Prismatic Glass Refractor	6.7 (14.9)

Dimensions in Millimeters (Inches)

Clear/Diffused/Glass Globes

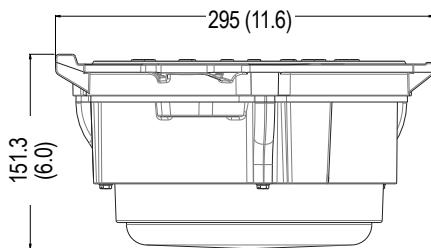

Short Prismatic Glass Refractor

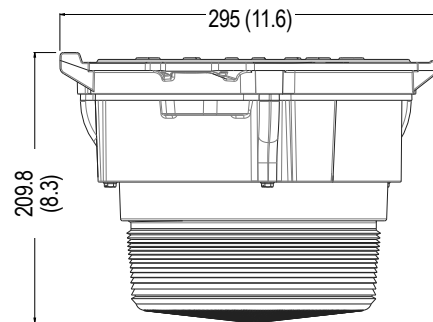

Ⓢ AEx rating is only applicable to product configurations with terminal block wiring option

Contender™ LED Series Luminaires

Enclosed and Gasketed Fixtures — Hazardous Locations

NEC/CEC: Class I, Division 2, Groups A,B,C,D | Class I, Zone 2, AEx ec IIC Ⓢ | Class II, Division 1, Groups E,F,G | Zone 21, AEx tb IIC Ⓢ | Class II, Division 2, Groups F,G | Class III | Type 3R, 4, 4X | IP66/67 | Simultaneous Exposure | Suitable for Use in Wet Locations | Marine Outside Type (Salt Water)
 Notable: American Bureau of Shipping (ABS) Certified | International Dark Sky (IDA) Approved

LED Luminaires | Area / Task | Hazardous Location | NEC / CEC

Photometric Data — DATA SHOWN IS ABSOLUTE

Type V, Clear Polycarbonate, 5000K CCT

REPORT NUMBER: VMV3LCP5BU

Luminaire Lumens 3,198

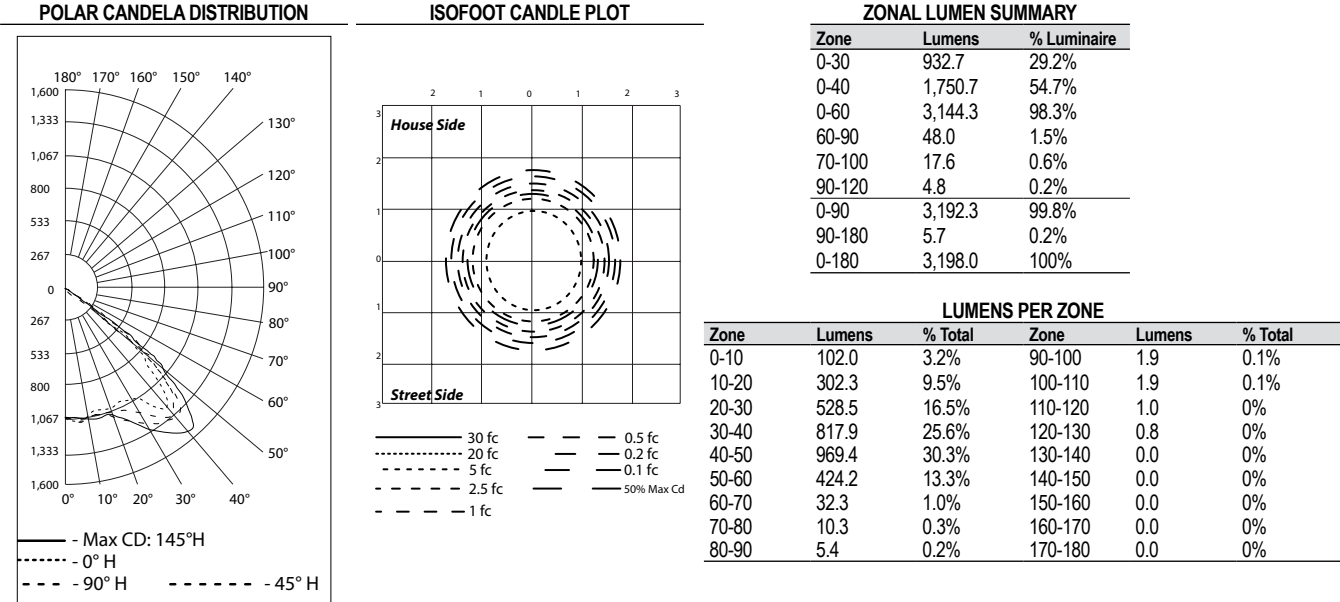

Type V, Clear Polycarbonate, 5000K CCT

REPORT NUMBER: VMV3LCD5BU

Luminaire Lumens 3,103

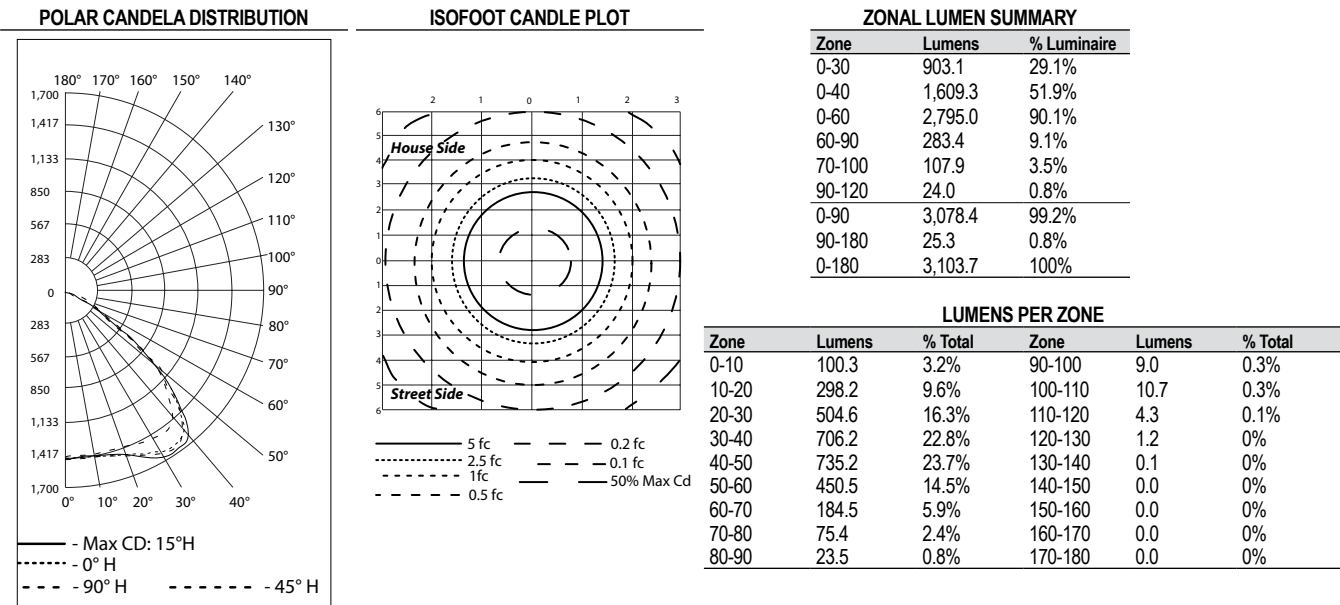

Ⓢ AEx rating is only applicable to product configurations with terminal block wiring option

Contender™ LED Series Luminaires

Enclosed and Gasketed Fixtures — Hazardous Locations

NEC/CEC: Class I, Division 2, Groups A,B,C,D | Class I, Zone 2, AEx ec IIC Ⓢ | Class II, Division 1, Groups E,F,G | Zone 21, AEx tb IIC Ⓢ | Class II, Division 2, Groups F,G | Class III | Type 3R, 4, 4X | IP66/67 | Simultaneous Exposure | Suitable for Use in Wet Locations | Marine Outside Type (Salt Water)
 Notable: American Bureau of Shipping (ABS) Certified | International Dark Sky (IDA) Approved

Photometric Data — DATA SHOWN IS ABSOLUTE

Type V, Clear Polycarbonate, 5000K CCT

REPORT NUMBER: VMV3LCG5BU

Luminaire Lumens 3,334

POLAR CANDELA DISTRIBUTION

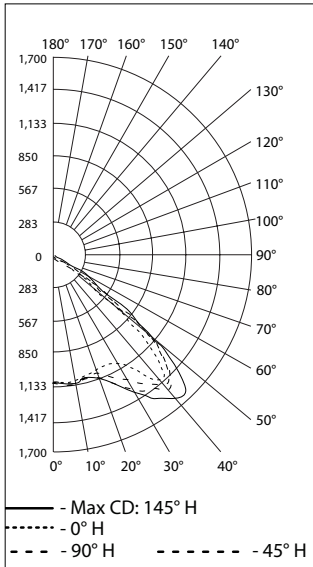

ISOFOOT CANDLE PLOT

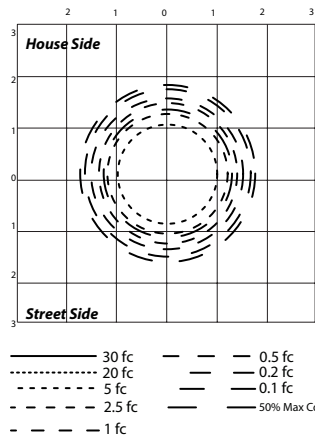

ZONAL LUMEN SUMMARY

Zone	Lumens	% Luminaire
0-30	960.0	28.8%
0-40	1,828.8	54.8%
0-60	3,298.1	98.9%
60-90	32.1	1%
70-100	8.4	0.3%
90-120	3.9	0.1%
0-90	3,330.2	99.9%
90-180	4.2	0.1%
0-180	3,334.5	100%

LUMENS PER ZONE

Zone	Lumens	% Total	Zone	Lumens	% Total
0-10	105.6	3.2%	90-100	1.1	0%
10-20	309.3	9.3%	100-110	1.2	0%
20-30	545.0	16.3%	110-120	1.6	0%
30-40	868.8	26.1%	120-130	0.3	0%
40-50	1,049.7	31.5%	130-140	0.0	0%
50-60	419.6	12.6%	140-150	0.1	0%
60-70	24.8	0.7%	150-160	0.0	0%
70-80	4.9	0.1%	160-170	0.0	0%
80-90	2.4	0.1%	170-180	0.0	0%

Type V, Clear Polycarbonate, 5000K CCT

REPORT NUMBER: VMV3LCJ5BU

Luminaire Lumens 3,020

POLAR CANDELA DISTRIBUTION

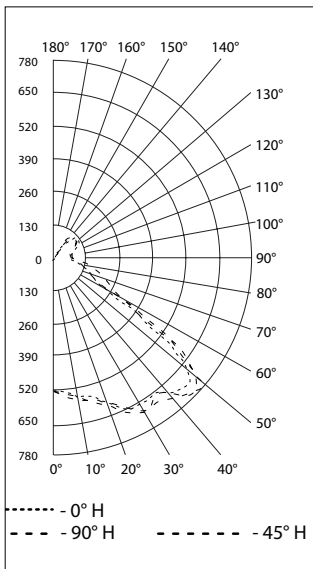

ISOFOOT CANDLE PLOT

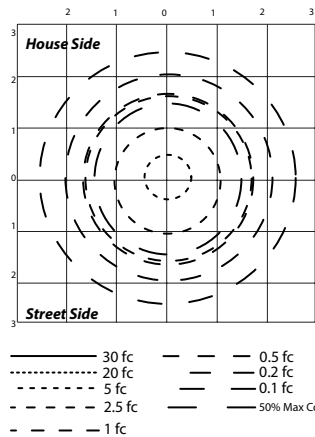

ZONAL LUMEN SUMMARY

Zone	Lumens	% Luminaire
0-30	526.8	17.4%
0-40	959.4	31.8%
0-60	2,035.0	67.4%
60-90	516.7	17.1%
70-100	363.7	12%
90-120	231.1	7.6%
0-90	2,551.7	84.5%
90-180	468.9	15.5%
0-180	3,020.6	100%

LUMENS PER ZONE

Zone	Lumens	% Total	Zone	Lumens	% Total
0-10	52.5	1.7%	90-100	81.0	2.7%
10-20	167.2	5.5%	100-110	70.8	2.3%
20-30	307.0	10.2%	110-120	79.3	2.6%
30-40	432.6	14.3%	120-130	104.8	3.5%
40-50	573.9	19.0%	130-140	90.3	3%
50-60	501.7	16.6%	140-150	37.8	1.3%
60-70	234.1	7.7%	150-160	4.9	0.2%
70-80	167.4	5.5%	160-170	0.0	0%
80-90	115.3	3.8%	170-180	0.0	0%

Ⓢ AEx rating is only applicable to product configurations with terminal block wiring option

Contender™ LED Series Luminaires

Enclosed and Gasketed Fixtures — Hazardous Locations

NEC/CEC: Class I, Division 2, Groups A,B,C,D | Class I, Zone 2, AEx ec IIC Ⓢ | Class II, Division 1, Groups E,F,G | Zone 21, AEx tb IIC Ⓢ | Class II, Division 2, Groups F,G | Class III | Type 3R, 4, 4X | IP66/67 | Simultaneous Exposure | Suitable for Use in Wet Locations | Marine Outside Type (Salt Water)
 Notable: American Bureau of Shipping (ABS) Certified | International Dark Sky (IDA) Approved

LED Luminaires | Area / Task | Hazardous Location | NEC / CEC

Photometric Data — DATA SHOWN IS ABSOLUTE

Type V, Clear Polycarbonate, 5000K CCT

REPORT NUMBER: VMV4LCP5BU

Luminaire Lumens 4,234

POLAR CANDELA DISTRIBUTION

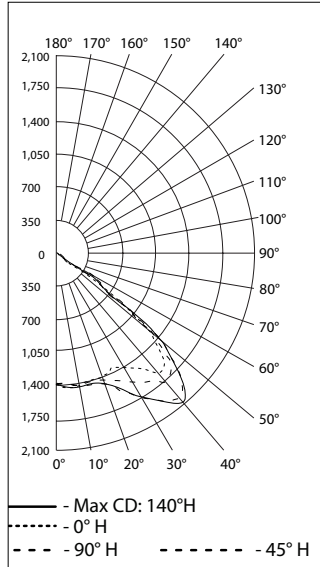

ISOFOOT CANDLE PLOT

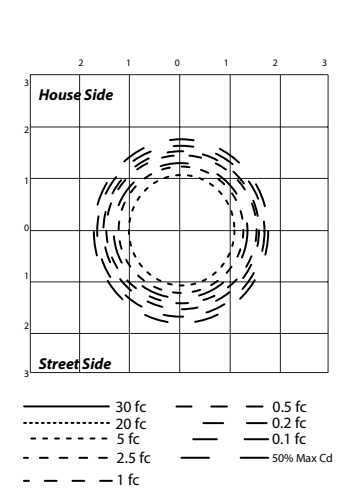

ZONAL LUMEN SUMMARY

Zone	Lumens	% Luminaire
0-30	1,229.4	29%
0-40	2,320.7	54.8%
0-60	4,178.7	98.7%
60-90	49.5	1.2%
70-100	18.7	0.4%
90-120	5.2	0.1%
0-90	4,228.2	99.9%
90-180	6.0	0.1%
0-180	4,234.3	100%

LUMENS PER ZONE

Zone	Lumens	% Total	Zone	Lumens	% Total
0-10	134.1	3.2%	90-100	2.3	0.1%
10-20	396.8	9.4%	100-110	1.9	0%
20-30	698.5	16.5%	110-120	1.0	0%
30-40	1,091.3	25.8%	120-130	0.8	0%
40-50	1,302.8	30.8%	130-140	0.0	0%
50-60	555.3	13.1%	140-150	0.0	0%
60-70	33.0	0.8%	150-160	0.0	0%
70-80	10.5	0.2%	160-170	0.0	0%
80-90	5.9	0.1%	170-180	0.0	0%

Type V, Clear Polycarbonate, 5000K CCT

REPORT NUMBER: VMV4LCD5BU

Luminaire Lumens 4,151

POLAR CANDELA DISTRIBUTION

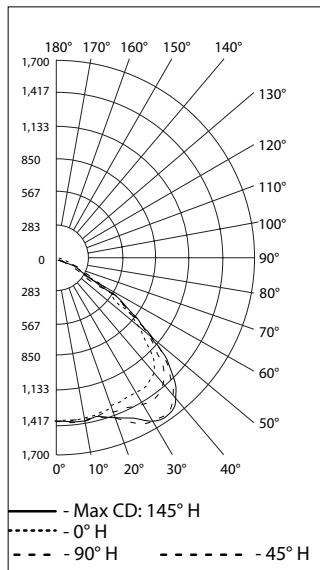

ISOFOOT CANDLE PLOT

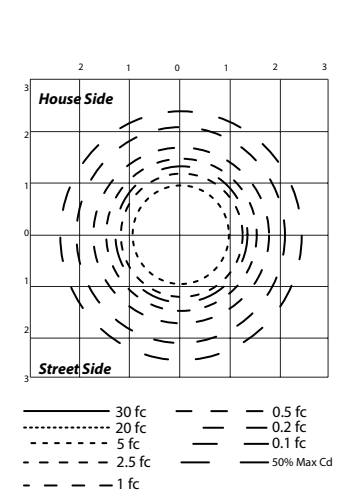

ZONAL LUMEN SUMMARY

Zone	Lumens	% Luminaire
0-30	1,206.1	29.1%
0-40	2,153.6	51.9%
0-60	3,742.1	90.2%
60-90	375.5	9%
70-100	142.2	3.4%
90-120	31.3	0.8%
0-90	4,117.6	99.2%
90-180	33.1	0.8%
0-180	4,150.7	100%

LUMENS PER ZONE

Zone	Lumens	% Total	Zone	Lumens	% Total
0-10	133.5	3.2%	90-100	11.7	0.3%
10-20	397.0	9.6%	100-110	14.0	0.3%
20-30	675.6	16.3%	110-120	5.5	0.1%
30-40	947.5	22.8%	120-130	1.6	0%
40-50	986.1	23.8%	130-140	0.1	0%
50-60	602.4	14.5%	140-150	0.1	0%
60-70	245.0	5.9%	150-160	0.0	0%
70-80	99.5	2.4%	160-170	0.0	0%
80-90	30.9	0.7%	170-180	0.0	0%

Ⓢ AEx rating is only applicable to product configurations with terminal block wiring option

Contender™ LED Series Luminaires

Enclosed and Gasketed Fixtures — Hazardous Locations

NEC/CEC: Class I, Division 2, Groups A,B,C,D | Class I, Zone 2, AEx ec IIC Ⓢ | Class II, Division 1, Groups E,F,G | Zone 21, AEx tb IIC Ⓢ | Class II, Division 2, Groups F,G | Class III | Type 3R, 4, 4X | IP66/67 | Simultaneous Exposure | Suitable for Use in Wet Locations | Marine Outside Type (Salt Water)
 Notable: American Bureau of Shipping (ABS) Certified | International Dark Sky (IDA) Approved

Photometric Data — DATA SHOWN IS ABSOLUTE

Type V, Clear Polycarbonate, 5000K CCT

REPORT NUMBER: VMV4LCG5BU

Luminaire Lumens 4,468

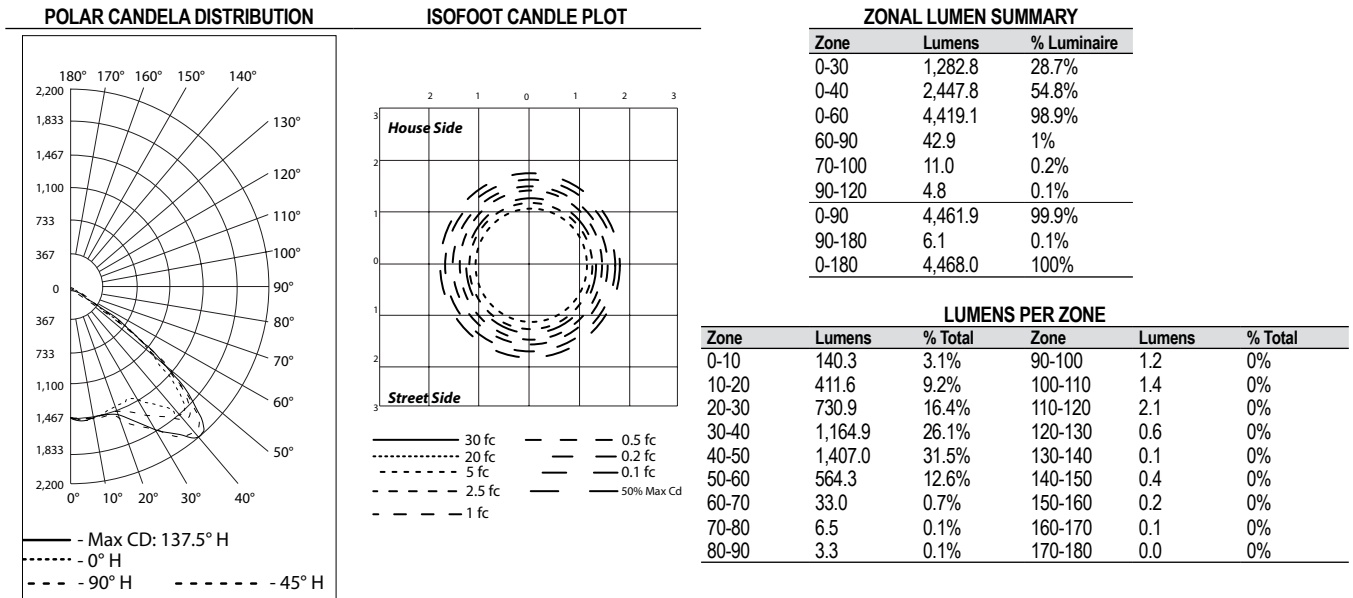

Type V, Clear Polycarbonate, 5000K CCT

REPORT NUMBER: VMV4LCJ5BU

Luminaire Lumens 4,020

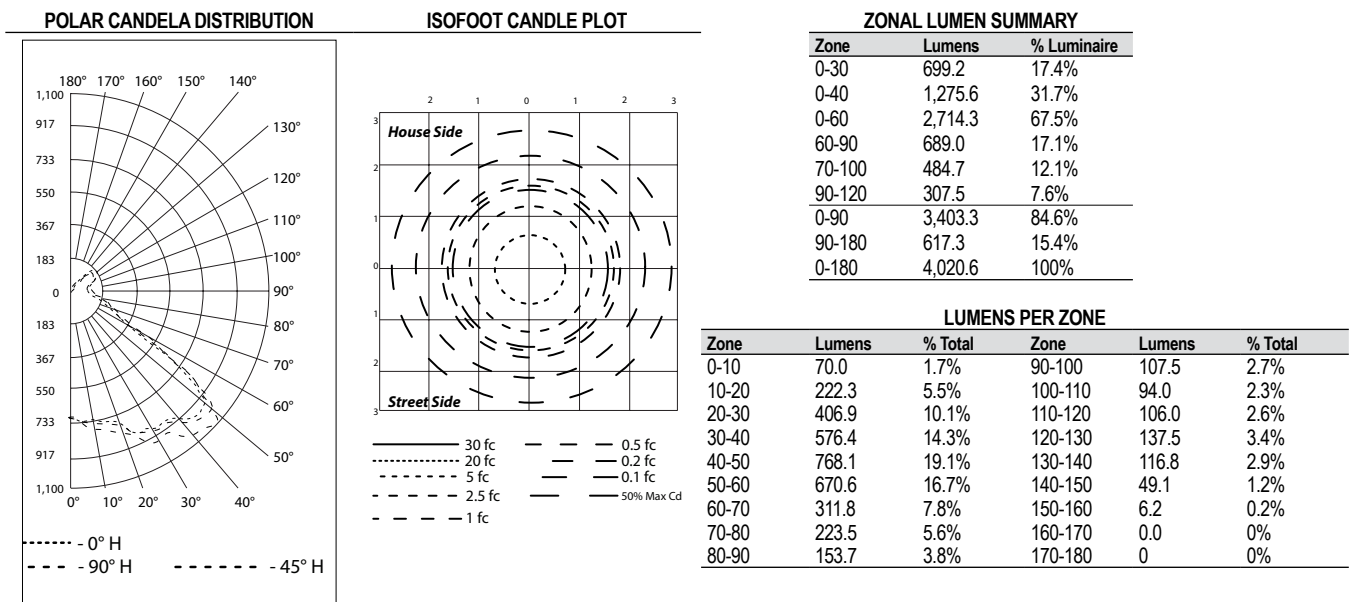

Ⓢ AEx rating is only applicable to product configurations with terminal block wiring option

Contender™ LED Series Luminaires

Enclosed and Gasketed Fixtures — Hazardous Locations

NEC/CEC: Class I, Division 2, Groups A,B,C,D | Class I, Zone 2, AEx ec IIC Ⓢ | Class II, Division 1, Groups E,F,G | Zone 21, AEx tb IIC Ⓢ | Class II, Division 2, Groups F,G | Class III | Type 3R, 4, 4X | IP66/67 | Simultaneous Exposure | Suitable for Use in Wet Locations | Marine Outside Type (Salt Water)
 Notable: American Bureau of Shipping (ABS) Certified | International Dark Sky (IDA) Approved

LED Luminaires | Area / Task | Hazardous Location | NEC / CEC

Photometric Data — DATA SHOWN IS ABSOLUTE

Type V, Clear Polycarbonate, 5000K CCT

REPORT NUMBER: VMV5LCP5BU

Luminaire Lumens 5,330

POLAR CANDELA DISTRIBUTION

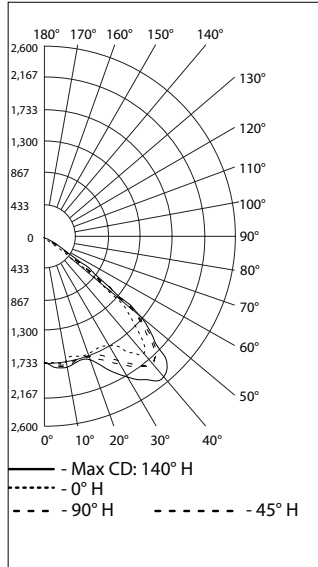

ISOFOOT CANDLE PLOT

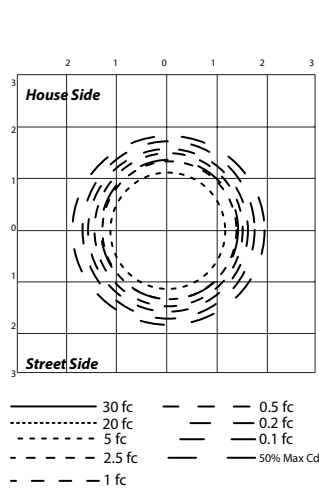

ZONAL LUMEN SUMMARY

Zone	Lumens	% Luminaire
0-30	1,525.8	28.6%
0-40	2,872.5	53.9%
0-60	5,237.4	98.3%
60-90	82.4	1.5%
70-100	29.4	0.6%
90-120	7.9	0.1%
0-90	5,319.8	99.8%
90-180	10.7	0.2%
0-180	5,330.5	100%

LUMENS PER ZONE

Zone	Lumens	% Total	Zone	Lumens	% Total
0-10	166.7	3.1%	90-100	3.1	0.1%
10-20	493.8	9.3%	100-110	3.0	0.1%
20-30	865.2	16.2%	110-120	1.7	0%
30-40	1,346.8	25.3%	120-130	0.9	0%
40-50	1,619.8	30.4%	130-140	0.6	0%
50-60	745.2	14.0%	140-150	0.6	0%
60-70	56.1	1.1%	150-160	0.4	0%
70-80	17.0	0.3%	160-170	0.2	0%
80-90	9.2	0.2%	170-180	0.1	0%

Type V, Clear Polycarbonate, 5000K CCT

REPORT NUMBER: VMV5LCD5BU

Luminaire Lumens 5,150

POLAR CANDELA DISTRIBUTION

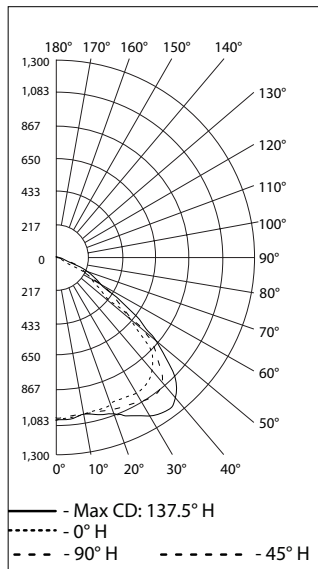

ISOFOOT CANDLE PLOT

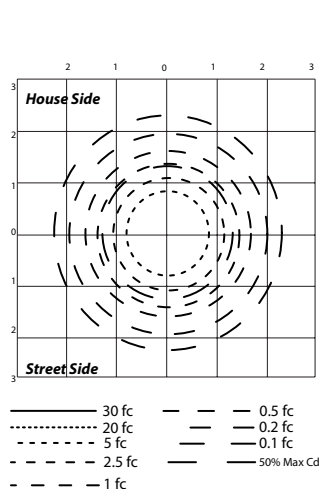

ZONAL LUMEN SUMMARY

Zone	Lumens	% Luminaire
0-30	1,484.5	28.8%
0-40	2,652.4	51.5%
0-60	4,632.4	89.9%
60-90	475.6	9.2%
70-100	180.0	3.5%
90-120	39.1	0.8%
0-90	5,108.0	99.2%
90-180	42.1	0.8%
0-180	5,150.1	100%

LUMENS PER ZONE

Zone	Lumens	% Total	Zone	Lumens	% Total
0-10	164.4	3.2%	90-100	14.5	0.3%
10-20	488.7	9.5%	100-110	17.8	0.3%
20-30	831.4	16.1%	110-120	6.9	0.1%
30-40	1,167.9	22.7%	120-130	2.0	0%
40-50	1,223.7	23.8%	130-140	0.3	0%
50-60	756.3	14.7%	140-150	0.2	0%
60-70	310.0	6.0%	150-160	0.2	0%
70-80	125.8	2.4%	160-170	0.1	0%
80-90	39.8	0.8%	170-180	0.1	0%

Ⓢ AEx rating is only applicable to product configurations with terminal block wiring option

Contender™ LED Series Luminaires

Enclosed and Gasketed Fixtures — Hazardous Locations

NEC/CEC: Class I, Division 2, Groups A,B,C,D | Class I, Zone 2, AEx ec IIC Ⓢ | Class II, Division 1, Groups E,F,G | Zone 21, AEx tb IIC Ⓢ | Class II, Division 2, Groups F,G | Class III | Type 3R, 4, 4X | IP66/67 | Simultaneous Exposure | Suitable for Use in Wet Locations | Marine Outside Type (Salt Water)
 Notable: American Bureau of Shipping (ABS) Certified | International Dark Sky (IDA) Approved

Photometric Data — DATA SHOWN IS ABSOLUTE

Type V, Clear Polycarbonate, 5000K CCT

REPORT NUMBER: VMV5LCG5BU

Luminaire Lumens 5,529

POLAR CANDELA DISTRIBUTION

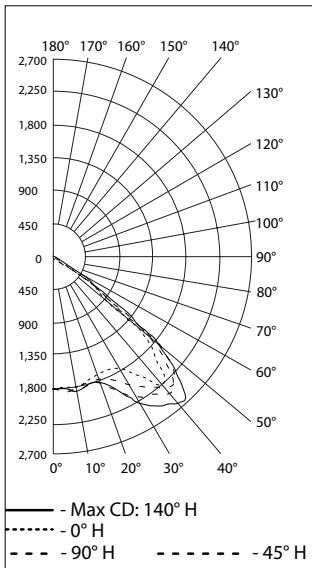

ISOFOOT CANDLE PLOT

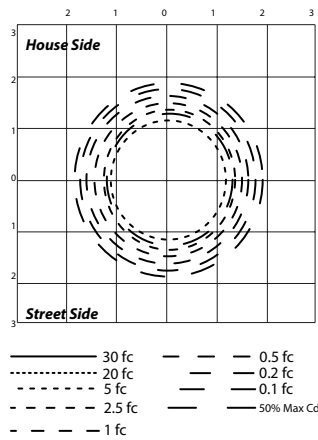

ZONAL LUMEN SUMMARY

Zone	Lumens	% Luminaire
0-30	1,575.5	28.5%
0-40	2,990.6	54.1%
0-60	5,434.7	98.3%
60-90	81.6	1.5%
70-100	27.7	0.5%
90-120	10.6	0.2%
0-90	5,516.3	99.8%
90-180	13.4	0.2%
0-180	5,529.7	100%

LUMENS PER ZONE

Zone	Lumens	% Total	Zone	Lumens	% Total
0-10	173.1	3.1%	90-100	3.8	0.1%
10-20	506.7	9.2%	100-110	3.3	0.1%
20-30	895.7	16.2%	110-120	3.5	0.1%
30-40	1,415.1	25.6%	120-130	1.3	0%
40-50	1,712.6	31.0%	130-140	0.5	0%
50-60	731.4	13.2%	140-150	0.4	0%
60-70	57.6	1.0%	150-160	0.4	0%
70-80	15.7	0.3%	160-170	0.2	0%
80-90	8.2	0.1%	170-180	0.1	0%

Type V, Clear Polycarbonate, 5000K CCT

REPORT NUMBER: VMV5LCJ5BU

Luminaire Lumens 4,940

POLAR CANDELA DISTRIBUTION

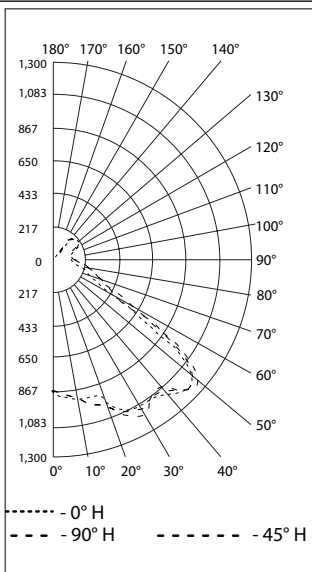

ISOFOOT CANDLE PLOT

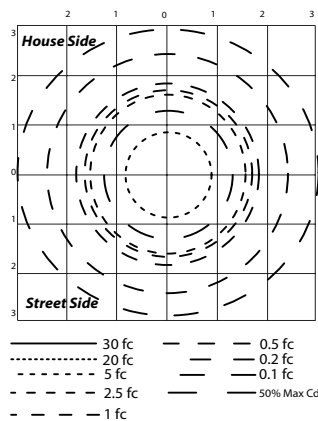

ZONAL LUMEN SUMMARY

Zone	Lumens	% Luminaire
0-30	872.9	17.7%
0-40	1,570.0	31.8%
0-60	3,310.7	67%
60-90	861.5	17.4%
70-100	606.8	12.3%
90-120	378.1	7.7%
0-90	4,172.1	84.4%
90-180	768.2	15.6%
0-180	4,940.4	100%

LUMENS PER ZONE

Zone	Lumens	% Total	Zone	Lumens	% Total
0-10	85.6	1.7%	90-100	134.2	2.7%
10-20	278.2	5.6%	100-110	116.1	2.3%
20-30	509.2	10.3%	110-120	127.8	2.6%
30-40	697.1	14.1%	120-130	169.8	3.4%
40-50	923.1	18.7%	130-140	148.5	3%
50-60	817.6	16.5%	140-150	63.2	1.3%
60-70	388.8	7.9%	150-160	8.4	0.2%
70-80	280.0	5.7%	160-170	0.1	0%
80-90	192.7	3.9%	170-180	0	0%

Ⓢ AEx rating is only applicable to product configurations with terminal block wiring option