

# FM7™ Conduit Outlet Bodies, Covers and Gaskets

For use with Rigid Steel, Rigid Aluminum and IMC Conduit.

NEC/CEC — Suitable for use in the following

Hazardous Locations:

Class I, Division 2 per NEC 501.10(B)(4)

Wet Locations, NEMA 3R with cover and gasket

## Applications

- Serve as pulling fittings.
- Make bends in conduit system.
- Provide openings for splicing.
- Connect and change direction of conduit runs.
- Allow connections for branch runs.
- Permit access to conductors for maintenance.

## Features

- Smooth, rounded integral bushings in hubs protect conductor insulation.
- Accurately tapped, tapered threads for tight, rigid joints and excellent ground continuity.
- Wedge-Lok™ Form-IN-Place covers with integral gasket are suitable for use in wet locations. Grayloy-iron bodies with cast covers and gasket are suitable for use in wet locations.
- Unique Wedge-Lok™ clip cover design allows easy removal at any later time, without damaging the conduit body. The cover is secured with clips, not screws.
- Completely interchangeable with Crouse-Hinds™ Form 7™ bodies, gaskets and covers. Equivalent FM7™ and Form 7™ units have identical applications and installation dimensions.
- Flat back design provides greater cubic content for easier wire pulling, and more room for splicing. Fits flush and snug against flat surfaces for more stable installation.
- Smooth hub bushings and cover openings protect conductor insulation. Smooth hub openings allow easy conduit joining.
- Pan-head cover screws secure cover clips and provide superior screwdriver seating and torque. Cover screws and clips are captive to prevent loss.
- Hub size, body style, compliance data, maximum wire number/size and cubic capacity molded into body.

## Standard Materials

- Body: Grayloy-iron or copperfree (4/10 of 1% max.) aluminum
- Covers: Grayloy-iron, copperfree (4/10 of 1% max.) aluminum or steel
- Cover screws: stainless steel

## Standard Finishes

- Grayloy-iron bodies and covers: triplecoat — (1) zinc electroplate, (2) chromate, and (3) epoxy powder coat
- Cast aluminum bodies and covers: epoxy powder coat
- Steel covers: zinc electroplate
- Stamped aluminum covers: natural finish

## Options

- No paint and coatings available on select bodies and covers. Add suffix **-NP** to catalog number.

## NEC/GEC Certifications and Compliances

- UL Standard: 514A , 514B
- UL Listed: E2527
- CSA Standard: C22.2 No. 18.3
- CSA Certified: 065183
- NEMA Standard: FB-1



Type LB

## Illustrated Features



Conduit Body with Cast Aluminum Cover, 1" Type C shown



Grayloy™-Iron, 1" Type C shown with cut-away body and cover to illustrate Wedge-Lok™ Clip Cover detail

Illustrated views are cut away to demonstrate back configurations.



Appleton™ FM7™ (C57, 1-1/2")  
28 Cubic Inches Capacity  
Flat-Back Design



Crouse-Hinds Form 7™  
(C57, 1-1/2")  
26 Cubic Inches Capacity



† Crouse-Hinds and Form 7™ are registered trademarks of Cooper Crouse-Hinds.



# FM7™ Conduit Outlet Bodies, Covers and Gaskets

For use with Rigid Steel, Rigid Aluminum and IMC Conduit.

NEC/CEC — Suitable for use in the following  
 Hazardous Locations:  
 Class I, Division 2 per NEC 501.10(B)(4)  
 Wet Locations, NEMA 3R with cover and  
 gasket

## Appleton™ FM7™ Conduit Bodies ①

Hub Size (Inches)	Max. Wire Fill	C		Max. Wire Fill	LB		Max. Wire Fill	LL	
		Grayloy-Iron	Aluminum ④		Grayloy-Iron	Aluminum ④		Grayloy-Iron	Aluminum ④
									
1/2	③	APPC17	APPC-17SA	③	APPLB17	APPLB-17SA	③	APPLL17	APPLL-17SA
3/4	(3) # 6	APPC27	APPC-27SA	(3) # 6	APPLB27	APPLB-27SA	(3) # 6	APPLL27	APPLL-27SA
1	(3) # 4	APPC37	APPC-37SA	(3) # 4	APPLB37	APPLB-37SA	(3) # 4	APPLL37	APPLL-37SA
1-1/4	(3) # 3	APPC47	APPC-47SA	(3) # 3	APPLB47	APPLB-47SA	(3) # 2	APPLL47	APPLL-47SA
1-1/2	(3) # 3	APPC57	APPC-57SA	(3) # 3	APPLB57	APPLB-57SA	(3) # 2	APPLL57	APPLL-57SA
2	(3) # 1/0	APPC67	APPC-67SA	(3) # 1/0	APPLB67	APPLB-67SA	(3) # 3/0	APPLL67	APPLL-67SA
2-1/2	(3) 2/0	APPC77	APPC-77SA	(3) 3/0	APPLB77	APPLB-77SA	(3) 250	APPLL77	APPLL-77SA
3	(3) 2/0	APPC87	APPC-87SA	(3) 2/0	APPLB87	APPLB-87SA	(3) 250	APPLL87	APPLL-87SA
3-1/2	—	—	—	(3) 300	APPLB97	APPLB-97SA	(3) 350	APPLL97	APPLL-97SA
4	—	—	—	(3) 350	APPLB107	APPLB-107SA	(3) 350	APPLL107	APPLL-107SA

Hub Size (Inches)	Max. Wire Fill	E		Max. Wire Fill	L ②		Max. Wire Fill	TA	
		Grayloy-Iron	Aluminum		Grayloy-Iron	Aluminum ④		Grayloy-Iron	Aluminum
									
1/2	③	APPE17	APPE-17SA	③	APPL17	—	③	APPTA17	—
3/4	(3) # 6	APPE27	APPE-27SA	(3) # 6	APPL27	—	(3) # 6	APPTA27	—
1	(3) # 4	APPE37	APPE-37SA	(3) # 4	APPL37	—	(3) # 4	APPTA37	—
1-1/4	—	—	—	(3) # 2	APPL47	—	(3) # 3	APPTA47	—
1-1/2	—	—	—	(3) # 2	APPL57	—	(3) # 2	APPTA57	—
2	—	—	—	(3) # 2	APPL67	—	(3) # 2	APPTA67	—

① Refer to following pages for Wiring Capacity Table.  
 ② L Unilets have double opening and are furnished with one steel cover, assembled.  
 ③ All 1/2" Max Wire Fill Calculations per the NEC - Annex C - Table C8.  
 ④ PVC coating available on select aluminum bodies. Add suffix **-PVC** to catalog number.

# FM7™ Conduit Outlet Bodies, Covers and Gaskets

For use with Rigid Steel, Rigid Aluminum and IMC Conduit.



NEC/CEC — Suitable for use in the following



Hazardous Locations:

Class I, Division 2 per NEC 501.10(B)(4)

Wet Locations, NEMA 3R with cover and gasket

## Appleton™ FM7™ Conduit Bodies ①

Hub Size (Inches)	Max. Wire Fill	LR		Max. Wire Fill	T	
		Grayloy-Iron	Aluminum ③		Grayloy-Iron	Aluminum ③
						
1/2	②	APPLR17	APPLR-17SA	②	APPT17	APPT-17SA
3/4	(3) # 6	APPLR27	APPLR-27SA	(3) # 6	APPT27	APPT-27SA
1	(3) # 4	APPLR37	APPLR-37SA	(3) # 4	APPT37	APPT-37SA
1-1/4	(3) # 2	APPLR47	APPLR-47SA	(3) # 3	APPT47	APPT-47SA
1-1/2	(3) # 2	APPLR57	APPLR-57SA	(3) # 3	APPT57	APPT-57SA
2	(3) # 2	APPLR67	APPLR-67SA	(3) # 2	APPT67	APPT-67SA
2-1/2	—	APPLR77	APPLR-77SA	(3) 1/0	APPT77	APPT-77SA
3	(3) 250	APPLR87	APPLR-87SA	(3) 1/0	APPT87	APPT-87SA
3-1/2	(3) 350	APPLR97	APPLR-97SA	(3) 3/0	APPT97	APPT-97SA
4	(3) 350	APPLR107	APPLR-107SA	(3) 3/0	APPT107	APPT-107SA

Hub Size (Inches)	Max. Wire Fill	TB		Max. Wire Fill	X	
		Grayloy-Iron	Aluminum ③		Grayloy-Iron	Aluminum ③
						
1/2	②	APPTB17	APPTB-17SA	②	APPX17	APPX-17SA
3/4	(3) # 6	APPTB27	APPTB-27SA	(3) # 6	APPX27	APPX-27SA
1	(3) # 4	APPTB37	APPTB-37SA	(3) # 4	APPX37	APPX-37SA
1-1/4	(3) # 3	APPTB47	APPTB-47SA	(3) # 3	APPX47	APPX-47SA
1-1/2	(3) # 2	APPTB57	APPTB-57SA	(3) # 2	APPX57	APPX-57SA
2	(3) # 2	APPTB67	APPTB-67SA	(3) # 2	APPX67	APPX-67SA

① Refer to following pages for Wiring Capacity Table.

② All 1/2" Max Wire Fill Calculations per the NEC - Annex C - Table C8.

③ PVC coating available on select aluminum bodies. Add suffix **-PVC** to catalog number..

# FM7™ Conduit Outlet Bodies, Covers and Gaskets

For use with Rigid Steel, Rigid Aluminum and IMC Conduit.



NEC/CEC — Suitable for use in the following

Hazardous Locations:

Class I, Division 2 per NEC 501.10(B)(4)

Wet Locations, NEMA 3R with cover and gasket

## Wedge-Lok™ Clip Covers, Gaskets (Covers furnished with stainless steel screws)

Body Size(Inches)	Wedge-Lok Cast Cover		Wedge-Lok Stamped Cover		Solid Neoprene Gasket
	Grayloy-Iron	Aluminum	Steel	Aluminum ①	
					
1/2	APP170F	APP170F-SA	APP170	APP170-SA	APPGASK571
3/4	APP270F	APP270F-SA	APP270	APP270-SA	APPGASK572
1	APP370F	APP370F-SA	APP370	APP370-SA	APPGASK573
1-1/4	APP470F	APP470F-SA	APP470	APP470-SA	APPGASK574
1-1/2	APP570F	APP570F-SA	APP570	APP570-SA	APPGASK575
2	APP670F	APP670F-SA	APP670	APP670-SA	APPGASK576
2-1/2	APP870F	APP870F-SA	APP870	APP870-SA	APPGASK578
3	APP870F	APP870F-SA	APP870	APP870-SA	APPGASK578
3-1/2	APP970F	APP970F-SA	APP970	APP970-SA	APPGASK579
4	APP970F	APP970F-SA	APP970	APP970-SA	APPGASK579

APPLETON™

COMMERCIAL AND INDUSTRIAL FITTINGS: CONDUIT BODIES

① PVC coating available on select aluminum covers. Add suffix **-PVC** to catalog number.

# FM7™ Conduit Outlet Bodies, Covers and Gaskets

For use with Rigid Steel, Rigid Aluminum and IMC Conduit.

NEC/CEC — Suitable for use in the following

Hazardous Locations:

Class I, Division 2 per NEC 501.10(B)(4)

Wet Locations, NEMA 3R with cover and gasket

## Wiring Capacity: Combine Body and Cover Capacities for Total Usable Capacity per NEC 314.16(A)

Hub Size (Inches)	Capacity — dm <sup>3</sup> (in <sup>3</sup> )									Stamped Cover	Cast Cover
	C	E	LB	LL LR	L	T	TA	TB	X		
<b>FM7™ Grayloy™-Iron Bodies and Covers: Threaded</b>											
1/2	0.07 (4.00)	0.07 (4.00)	0.07 (4.00)	0.07 (4.00)	0.08 (5.00)	0.10 (6.00)	0.10 (6.00)	0.10 (6.00)	0.10 (6.00)	0.00 (0.30)	0.01 (0.40)
3/4	0.11 (7.00)	0.11 (7.00)	0.11 (7.00)	0.11 (7.00)	0.15 (9.00)	0.16 (10.00)	0.16 (10.00)	0.16 (10.00)	0.16 (10.00)	0.01 (0.50)	0.01 (0.80)
1	0.18 (11.00)	0.18 (11.00)	0.18 (11.00)	0.18 (11.00)	0.22 (13.50)	0.25 (15.50)	0.25 (15.50)	0.25 (15.50)	0.25 (15.50)	0.02 (1.30)	0.02 (1.30)
1-1/4	0.33 (20.00)	—	0.33 (20.00)	0.33 (20.00)	0.37 (22.50)	0.33 (20.00)	0.33 (20.00)	0.33 (20.00)	0.33 (20.00)	0.03 (1.80)	0.03 (2.00)
1-1/2	0.46 (28.00)	—	0.46 (28.00)	0.46 (28.00)	0.51 (31.00)	0.46 (28.00)	0.46 (28.00)	0.46 (28.00)	0.46 (28.00)	0.04 (2.30)	0.05 (3.00)
2	0.82 (50.00)	—	0.82 (50.00)	0.82 (50.00)	0.82 (50.00)	0.82 (50.00)	0.82 (50.00)	0.82 (50.00)	0.82 (50.00)	0.05 (2.80)	0.08 (4.80)
2-1/2	1.67 (102.00)	—	1.67 (102.00)	1.67 (102.00)	—	1.67 (102.00)	—	—	—	0.16 (9.80)	0.16 (9.70)
3	2.18 (133.00)	—	2.18 (133.00)	2.18 (133.00)	—	2.18 (133.00)	—	—	—	0.16 (9.80)	0.16 (9.70)
3-1/2	—	—	3.57 (218.00)	3.57 (218.00)	—	3.57 (218.00)	—	—	—	0.27 (16.50)	0.26 (16.00)
4	—	—	4.00 (244.00)	4.00 (244.00)	—	4.00 (244.00)	—	—	—	0.27 (16.50)	0.26 (16.00)
<b>FM7™ Aluminum Bodies and Covers: Threaded</b>											
1/2	0.07 (4.00)	0.07 (4.00)	0.07 (4.00)	0.07 (4.00)	—	0.10 (6.00)	—	0.10 (6.00)	0.10 (6.00)	0.005 (0.30)	0.007 (0.40)
3/4	0.11 (7.00)	0.11 (7.00)	0.11 (7.00)	0.11 (7.00)	—	0.16 (10.00)	—	0.16 (10.00)	0.16 (10.00)	0.008 (0.50)	0.01 (0.80)
1	0.18 (11.00)	0.18 (11.00)	0.18 (11.00)	0.18 (11.00)	—	0.25 (15.50)	—	0.25 (15.50)	0.25 (15.50)	0.02 (1.30)	0.02 (1.30)
1-1/4	0.33 (20.00)	—	0.33 (20.00)	0.33 (20.00)	—	0.33 (20.00)	—	0.33 (20.00)	0.33 (20.00)	0.03 (1.80)	0.03 (2.00)
1-1/2	0.46 (28.00)	—	0.46 (28.00)	0.46 (28.00)	—	0.46 (28.00)	—	0.46 (28.00)	0.46 (28.00)	0.04 (2.30)	0.05 (3.00)
2	0.82 (50.00)	—	0.82 (50.00)	0.82 (50.00)	—	0.82 (50.00)	—	0.82 (50.00)	0.82 (50.00)	0.05 (2.80)	0.08 (4.80)
2-1/2	1.67 (102.00)	—	1.67 (102.00)	1.67 (102.00)	—	1.67 (102.00)	—	—	—	0.16 (9.80)	0.16 (9.70)
3	2.18 (133.00)	—	2.18 (133.00)	2.18 (133.00)	—	2.18 (133.00)	—	—	—	0.16 (9.80)	0.16 (9.70)
3-1/2	—	—	3.57 (218.00)	3.57 (218.00)	—	3.57 (218.00)	—	—	—	0.27 (16.50)	0.26 (16.00)
4	—	—	4.00 (244.00)	4.00 (244.00)	—	4.00 (244.00)	—	—	—	0.27 (16.50)	0.26 (16.00)

# FM7™ Conduit Outlet Bodies, Covers and Gaskets

FM7™ Covers with Integral Form-In-Place Gasket.

NEC/CEC:  
Class I, Division 2  
Wet Locations, NEMA 3R

## Applications

- Cover with integral gasket for FM7™ conduit bodies.
- Can be used as replacement covers for installed bodies or in new installations.

## Features

- Benefit from superior sealing, reduced inventory parts and faster installation times.
- Captive pan-head screws.
- Wedge-Lok™ clips (FM7™ only) provide superior screwdriver torque and cover seating.
- High-strength, corrosion and weather resistant.
- Approved for wet locations.
- Fits all body configurations and sizes from 1/2" thru 4".
- Operating temperature: -54 °C to +150 °C (-65 °F to +302 °F).





## Standard Materials

- Stamped steel
- Stamped aluminum
- Cast grayloy-iron
- Cast aluminum
- Gasket - Urethane

## NEC/CEC Certifications and Compliances

- UL Listed: E2527
- CSA Certified: 65183, Class 4413-02



Hub Size (Inches)	Stamped Steel	Stamped Aluminum	Cast Grayloy-Iron	Cast Aluminum
				
1/2	APP170IG	APP170IGSA	APP170FIG	APP170FIGSA
3/4	APP270IG	APP270IGSA	APP270FIG	APP270FIGSA
1	APP370IG	APP370IGSA	APP370FIG	APP370FIGSA
1-1/4	APP470IG	APP470IGSA	APP470FIG	APP470FIGSA
1-1/2	APP570IG	APP570IGSA	APP570FIG	APP570FIGSA
2	APP670IG	APP670IGSA	APP670FIG	APP670FIGSA
2-1/2 and 3	APP870IG	APP870IGSA	APP870FIG	APP870FIGSA
3-1/2 and 4	APP970IG	APP970IGSA	APP970FIG	APP970FIGSA

# FM7™ Conduit Outlet Bodies, Covers and Gaskets

For use with Rigid Steel, Rigid Aluminum and IMC Conduit.

NEC/CEC:  
Class I, Division 2  
Wet Locations, NEMA 3R

## Dimensions in Millimeters (Inches)

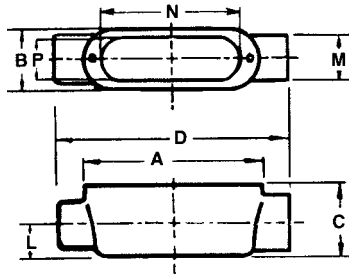

Type C

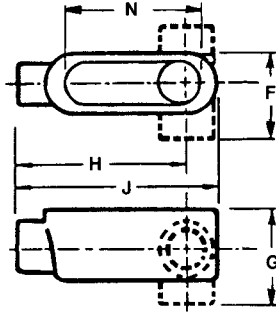

Type E, L, LB, LL, LR

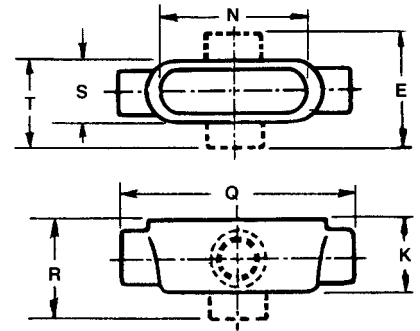

Type T, TA, TB, X

Hub Size (Inches)	Dimensions in Millimeters (Inches)																		
	A	B	C	D	E	F	G	H	J	K	L	M	N	P	Q	R	S	T	
1/2	92.2 (3.63)	35.1 (1.38)	35.1 (1.38)	136.7 (5.38)	84.1 (3.31)	57.2 (2.25)	57.2 (2.25)	100.1 (3.94)	115.8 (4.56)	44.5 (1.75)	16.0 (0.63)	31.8 (1.25)	81.0 (3.19)	23.9 (0.94)	143.0 (5.63)	66.8 (2.63)	39.6 (1.56)	62.0 (2.44)	
3/4	108.0 (4.25)	39.6 (1.56)	41.4 (1.63)	152.4 (6.00)	88.9 (3.50)	62.0 (2.44)	63.5 (2.50)	112.8 (4.44)	131.8 (5.19)	50.8 (2.00)	19.1 (0.75)	38.1 (1.50)	96.8 (3.81)	28.7 (1.13)	158.8 (6.25)	73.2 (2.88)	47.8 (1.88)	66.8 (2.63)	
1	127.0 (5.00)	44.5 (1.75)	47.8 (1.88)	177.8 (7.00)	98.6 (3.88)	69.9 (2.75)	73.2 (2.88)	131.8 (5.19)	152.4 (6.00)	57.2 (2.25)	22.4 (0.88)	44.5 (1.75)	114.3 (4.50)	35.1 (1.38)	184.2 (7.25)	82.6 (3.25)	50.8 (2.00)	76.2 (3.00)	
1-1/4	139.7 (5.50)	55.6 (2.19)	58.7 (2.31)	189.0 (7.44)	104.9 (4.13)	81.0 (3.19)	84.1 (3.31)	138.2 (5.44)	165.1 (6.50)	58.7 (2.31)	28.7 (1.13)	55.6 (2.19)	127.0 (5.00)	44.5 (1.75)	189.0 (7.44)	84.1 (3.31)	55.6 (2.19)	81.0 (3.19)	
1-1/2	152.4 (6.00)	62.0 (2.44)	65.0 (2.56)	208.0 (8.19)	117.6 (4.63)	88.9 (3.50)	93.7 (3.69)	150.9 (5.94)	181.1 (7.13)	65.0 (2.56)	31.8 (1.25)	62.0 (2.44)	138.2 (5.44)	49.3 (1.94)	208.0 (8.19)	92.2 (3.63)	62.0 (2.44)	90.4 (3.56)	
2	177.8 (7.00)	76.2 (3.00)	79.5 (3.13)	233.4 (9.19)	131.8 (5.19)	103.1 (4.06)	108.0 (4.25)	168.4 (6.63)	206.5 (8.13)	79.5 (3.13)	38.1 (1.50)	76.2 (3.00)	162.1 (6.38)	62.0 (2.44)	233.4 (9.19)	106.4 (4.19)	76.2 (3.00)	104.9 (4.13)	
2-1/2	228.6 (9.00)	108.0 (4.25)	92.2 (3.63)	304.8 (12.00)	—	146.1 (5.75)	130.3 (5.13)	222.3 (8.75)	266.7 (10.50)	92.2 (3.63)	44.5 (1.75)	88.9 (3.50)	212.9 (8.38)	90.4 (3.56)	304.8 (12.00)	—	108.0 (4.25)	146.1 (5.75)	
3	228.6 (9.00)	108.0 (4.25)	111.3 (4.38)	304.8 (12.00)	—	146.1 (5.75)	149.4 (5.88)	212.9 (8.38)	266.7 (10.50)	111.3 (4.38)	54.1 (2.13)	108.0 (4.25)	212.9 (8.38)	90.4 (3.56)	306.3 (12.06)	—	108.0 (4.25)	146.1 (5.75)	
3-1/2	279.4 (11.00)	133.4 (5.25)	124.0 (4.88)	—	—	176.3 (6.94)	166.6 (6.56)	260.4 (10.25)	322.3 (12.69)	124.0 (4.88)	60.5 (2.38)	120.7 (4.75)	260.4 (10.25)	114.3 (4.50)	363.5 (14.31)	—	133.4 (5.25)	176.3 (6.94)	
4	279.4 (11.00)	133.4 (5.25)	136.7 (5.38)	—	—	176.3 (6.94)	179.3 (7.06)	254.0 (10.00)	322.3 (12.69)	136.7 (5.38)	66.8 (2.63)	133.4 (5.25)	260.4 (10.25)	114.3 (4.50)	363.5 (14.31)	—	133.4 (5.25)	176.3 (6.94)	

## Fraction/Decimal Equivalents (Inches)

Fraction	Decimal	Fraction	Decimal	Fraction	Decimal	Fraction	Decimal
1/16	0.06	5/16	0.31	9/16	0.56	13/16	0.81
1/8	0.13	3/8	0.38	5/8	0.63	7/8	0.88
3/16	0.19	7/16	0.44	11/16	0.69	15/16	0.94
1/4	0.25	1/2	0.50	3/4	0.75	1	1.00